

LLB CRG Inelastic instruments at ILL: from IN6 to SHARP then SHARP⁺

S. Rodrigues¹, P. Lavie¹, B. Homatter¹, S. Petit¹, Q. Berrod²,
P. Permingeat¹, T. Robillard¹, F. Legendre¹ and J.-M. Zanotti¹

¹ Laboratoire Léon Brillouin , Saclay, France

² IRIG/SyMMES , Grenoble, France



SHARP (Spectromètre Hybride Alpes Region Parisienne)

Cold time-of-flight inelastic spectrometer by "time focusing" LLB CRG "A" at ILL

March 21 2021 : SHARP Up and Running

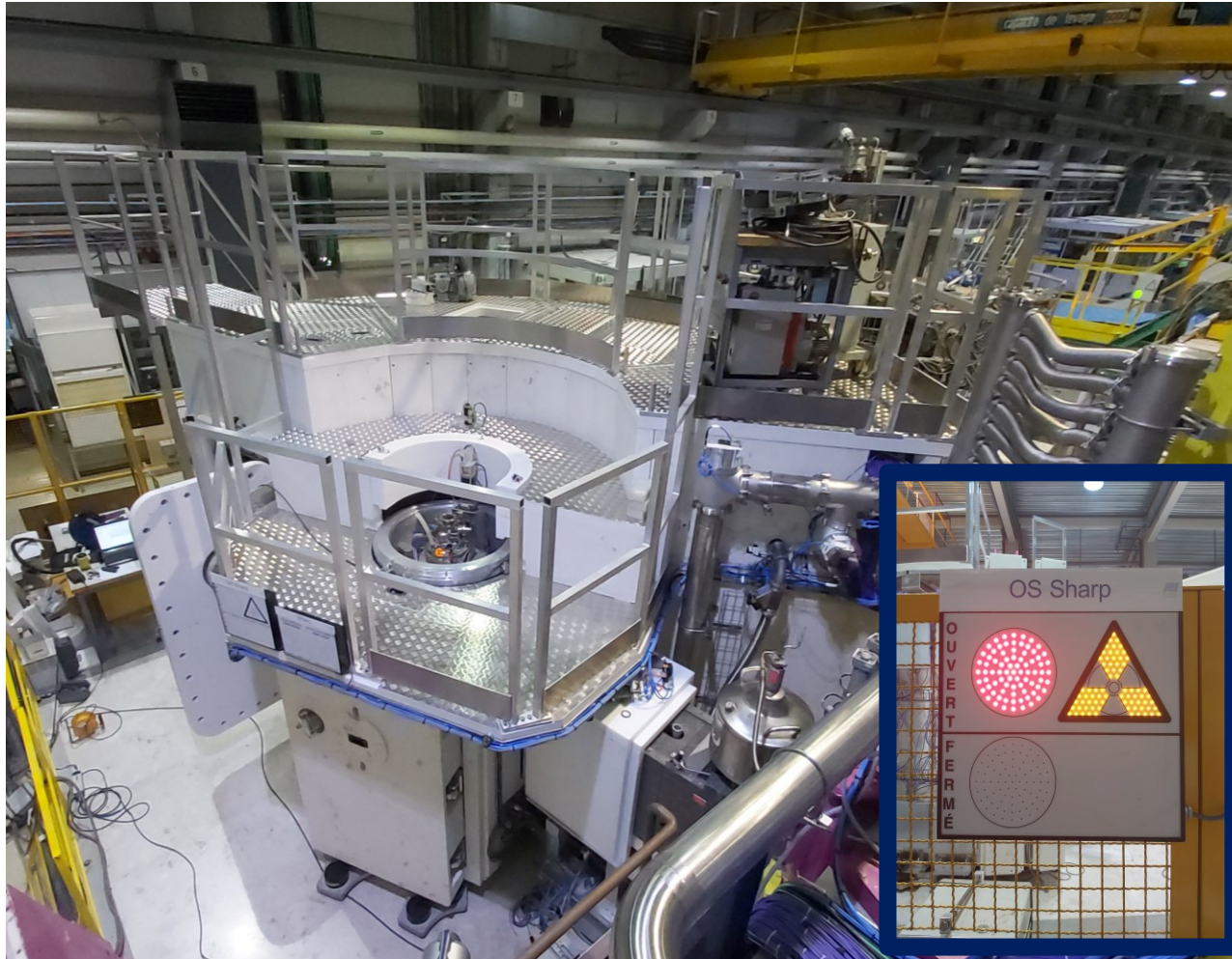

SHARP (Spectromètre Hybride Alpes Region Parisienne)

The Making-Of

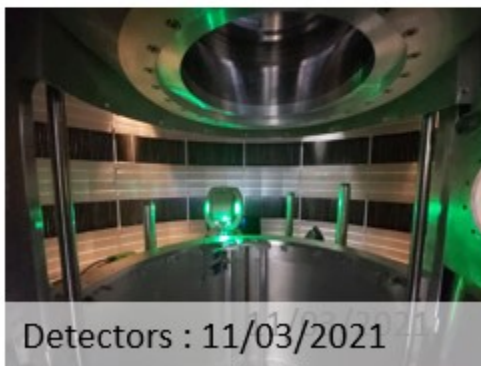
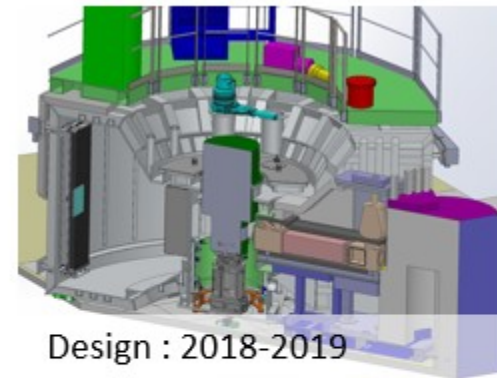

- Cycle 1: January 27 to March 30: Construction & first neutrons (March 21 2021)
- Cycle 2 : May 11 to July 14: Commissioning
- Cycle 3: August 24 to Oct. 13: Back to users granted beam time (50% 2FDN /50 %ILL)

NB: First neutrons in less than 5 months from the delivery of the "naked" chamber

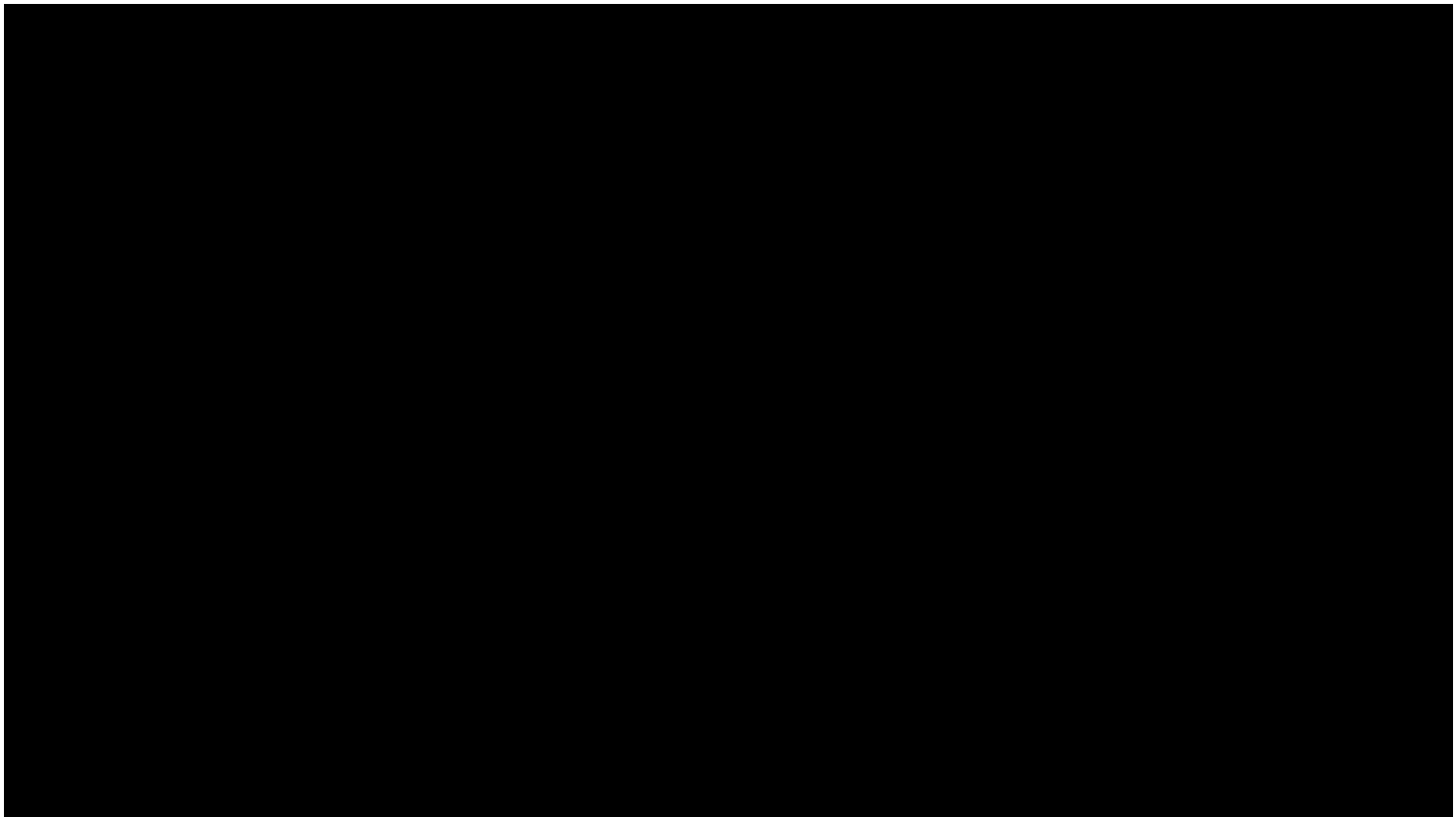

Study of dynamics and relaxation properties in condensed matter:

- Dynamics of soft condensed matter such as polymers, proteins, biological membranes and gels
- Local and long range diffusion of liquids, solutions and confined systems
- Vibrational density of states of crystalline and amorphous solids
- Properties of quantum liquids, Fermi and non-Fermi systems
- Phase transitions and quantum critical phenomena in polycrystals and single crystals
- Spin dynamics in high- T_c superconductors
- Properties of crystal field splitting

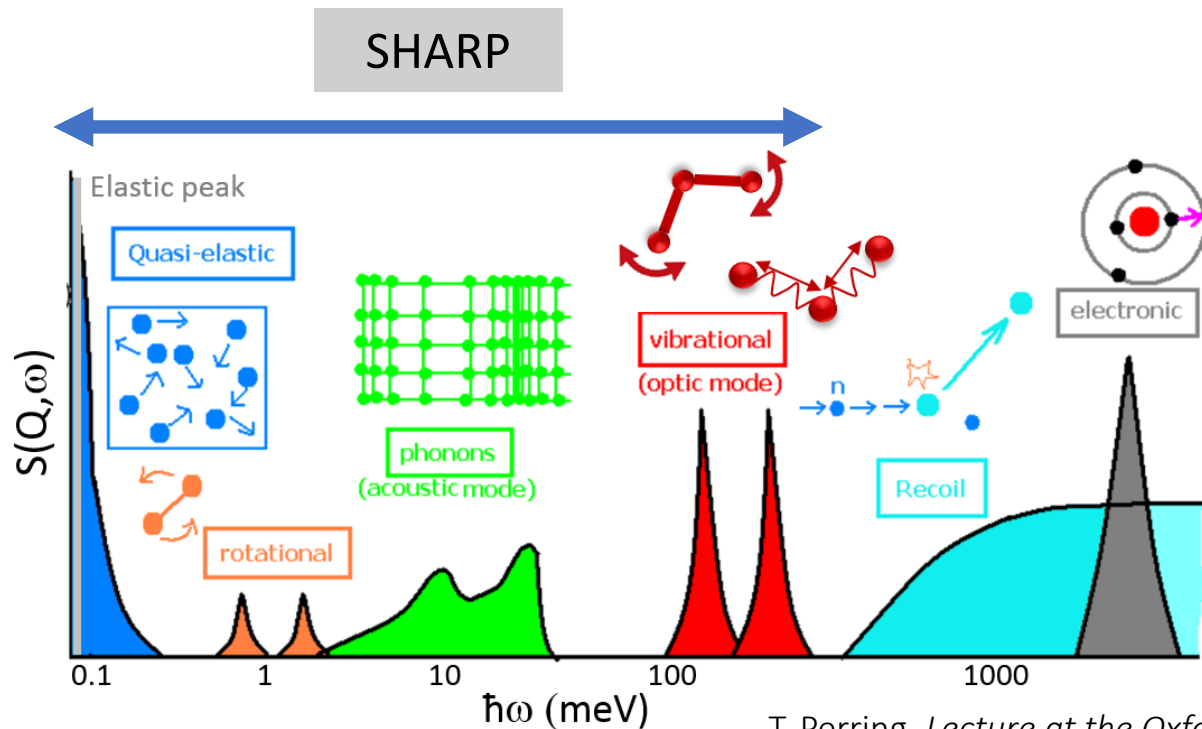

Mesot, Janssen, Holitzner & Hempelmann, J. Neutron Research, 3, 293-310 (1993).

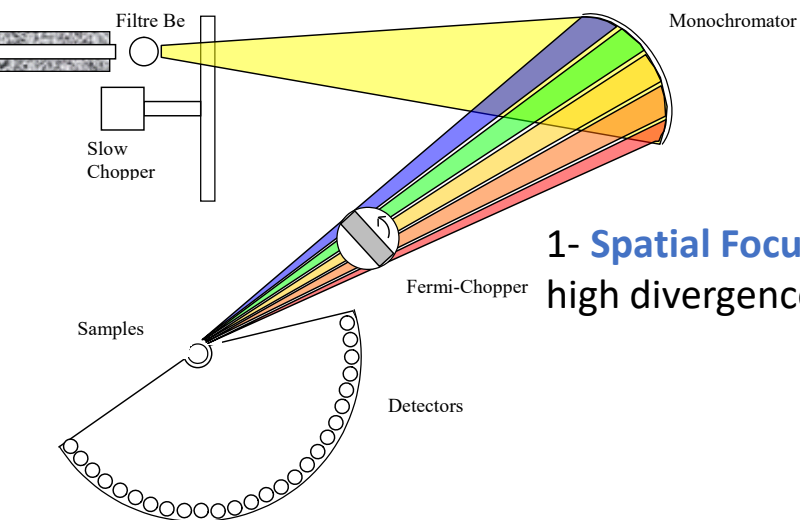

1- Spatial Focusing : focusing Monochromator to fully take advantage of the high divergence of the converging guide.

Mesot, Janssen, Holitzner & Hempelmann, J. Neutron Research, 3, 293-310 (1993).

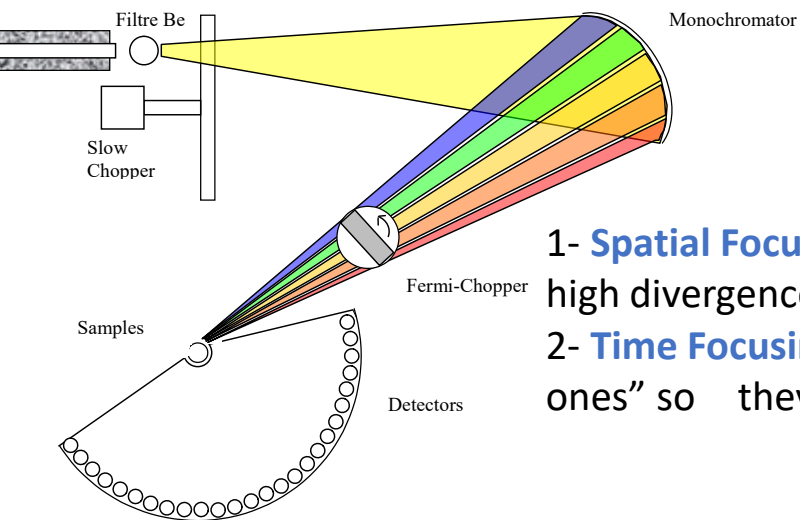

1- **Spatial Focusing** : focusing Monochromator to fully take advantage of the high divergence of the converging guide.

2- **Time Focusing**: Fermi Chopper let the “slow” neutrons start before the “fast ones” so they arrive at the same time at the detector --> good resolution

Fermi Chopper ($v_{Max} = 250 \text{ Hz}$)

Slit Package: Stack of Gd and Al. *thick* = 25 μm

Collimation = 2.1°

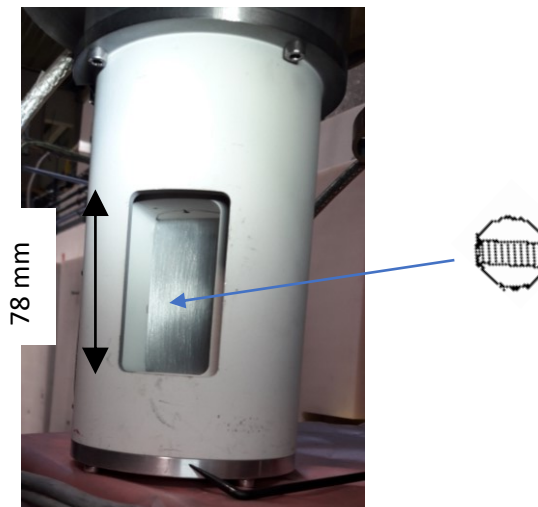

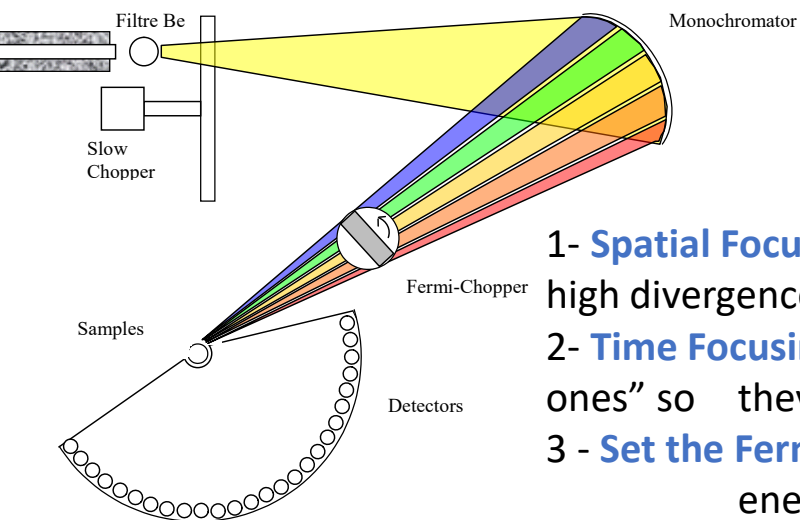

- 1- **Spatial Focusing** : focusing Monochromator to fully take advantage of the high divergence of the converging guide.
- 2- **Time Focusing**: Fermi Chopper let the “slow” neutrons start before the “fast ones” so they arrive at the same time at the detector --> good resolution
- 3 - **Set the Fermi chopper speed** to minimise the resolution at the desired energy transfer

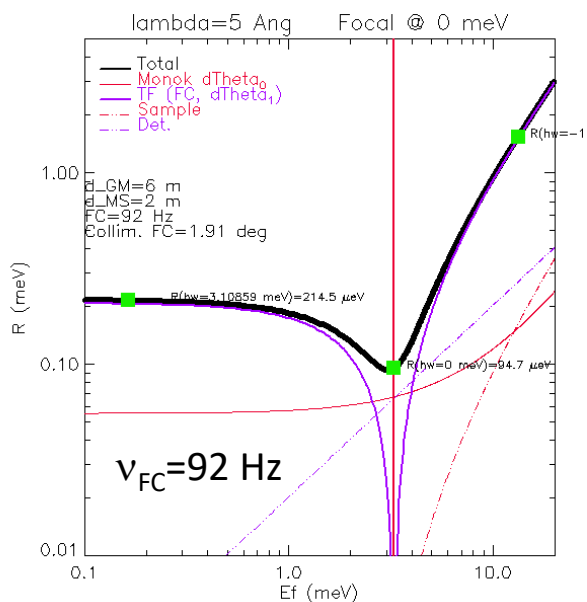

Mesot, Janssen, Holitzner & Hempelmann, J. Neutron Research, 3, 293-310 (1993).

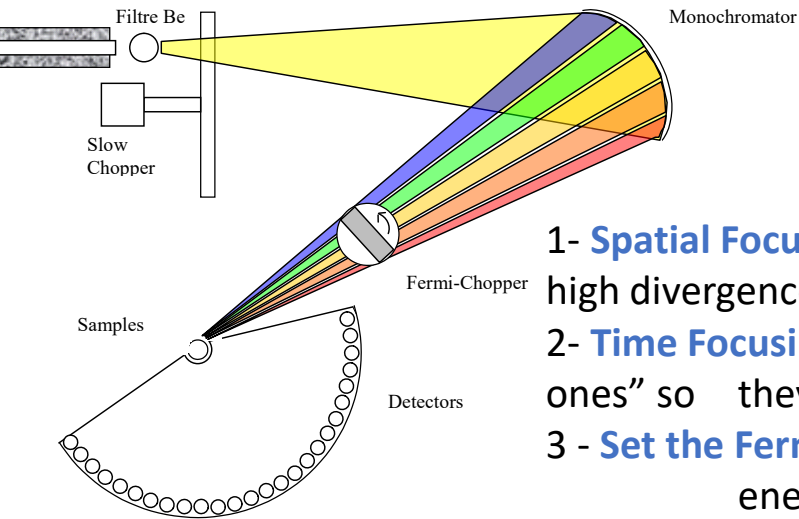

- 1- **Spatial Focusing** : focusing Monochromator to fully take advantage of the high divergence of the converging guide.
- 2- **Time Focusing**: Fermi Chopper let the “slow” neutrons start before the “fast ones” so they arrive at the same time at the detector --> good resolution
- 3 - **Set the Fermi chopper speed** to minimise the resolution at the desired energy transfer

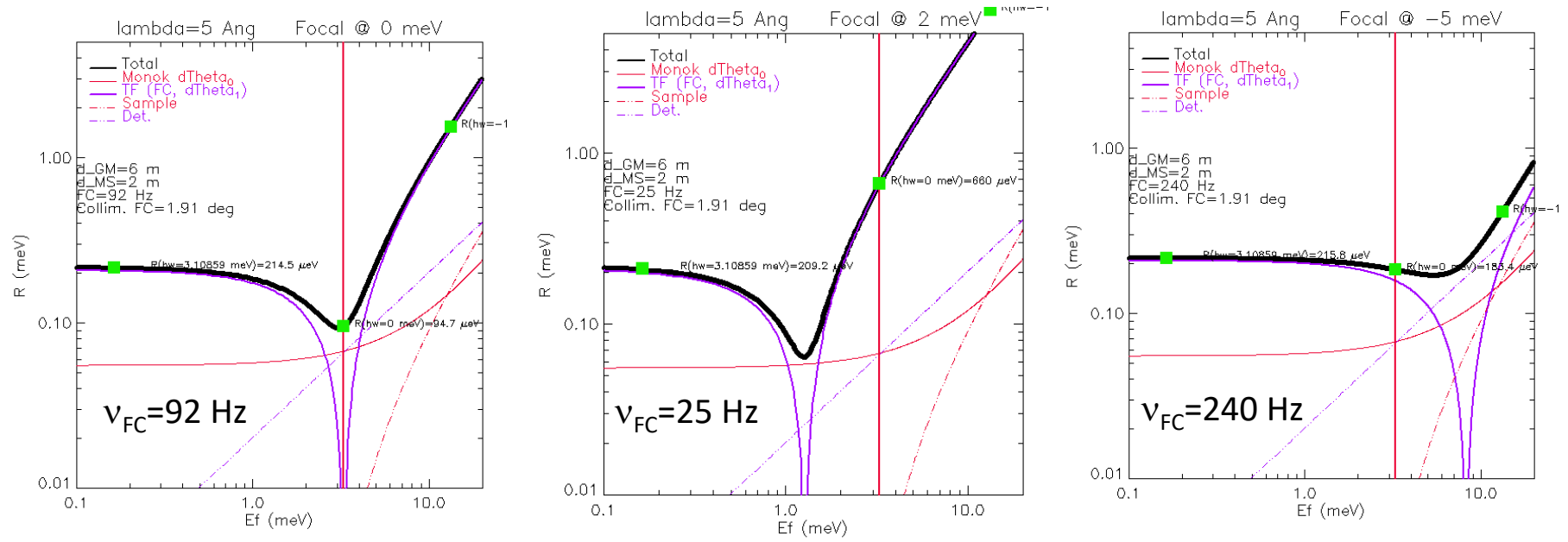

Sharp :

A state of the art ToF Spectrometer

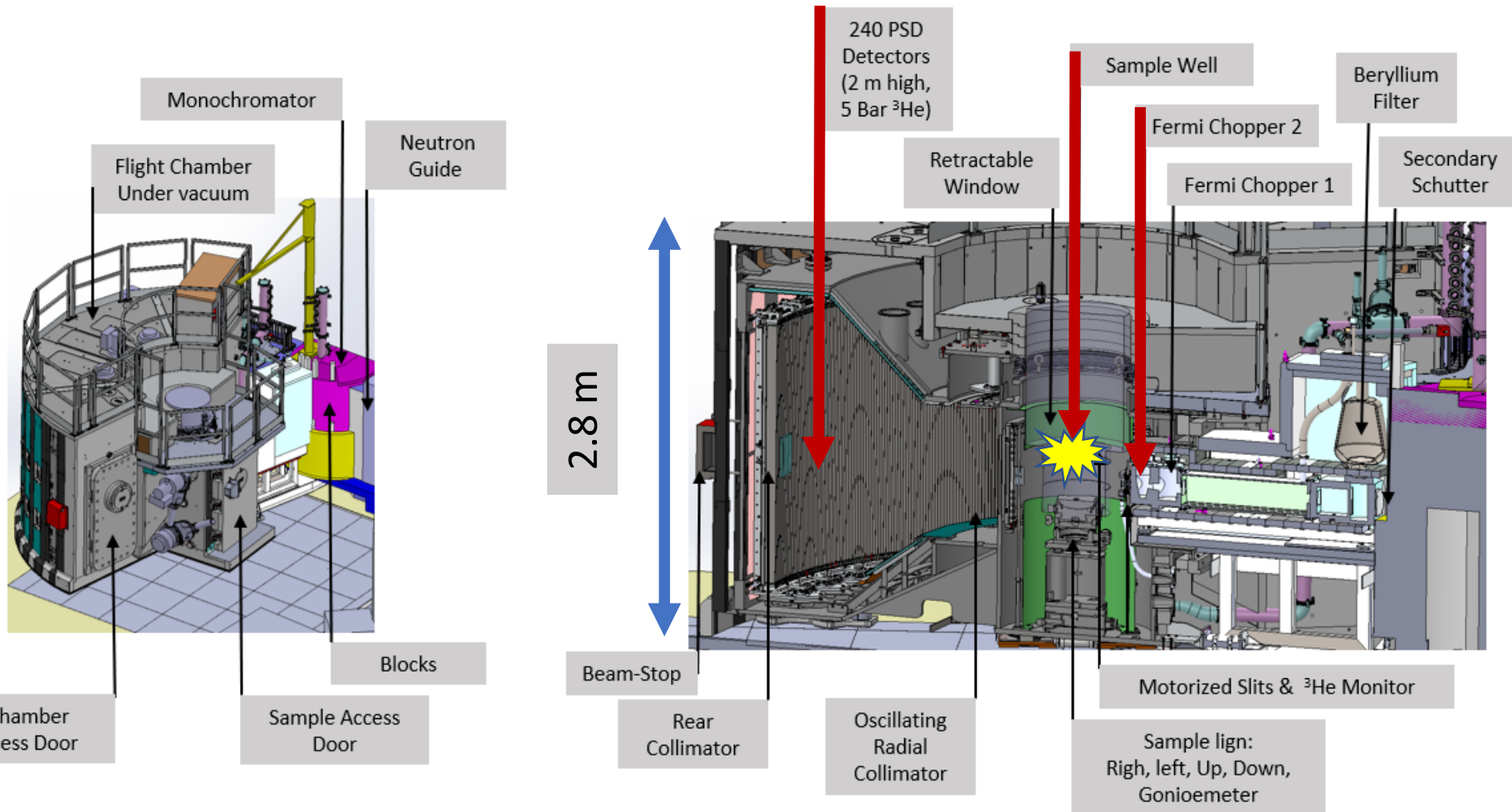

Sharp :

A state of the art ToF Spectrometer

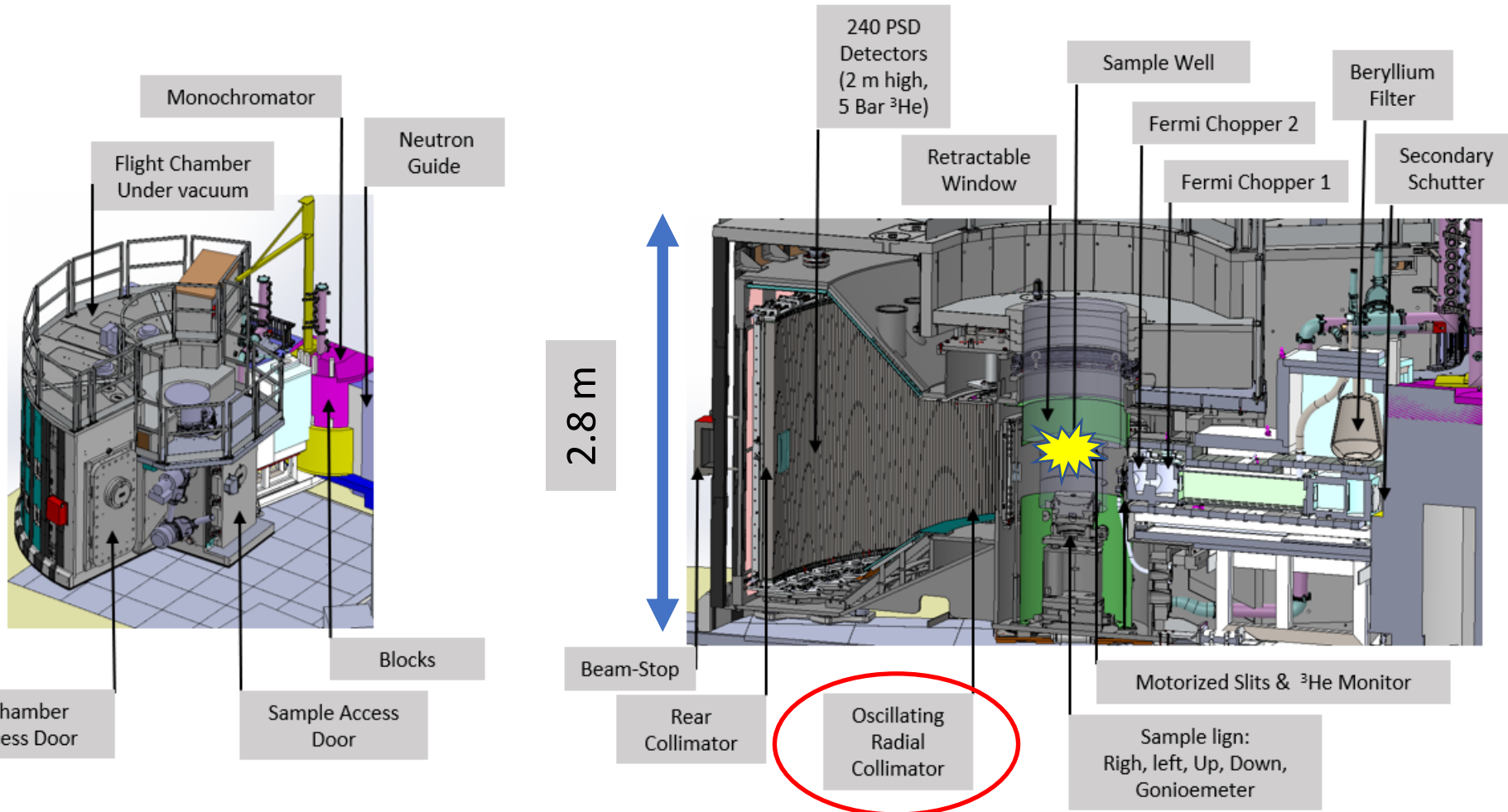

More on « time-of-flight » :

J. Ollivier et J.-M. Zanotti, Diffusion Inélastique de Neutrons par temps de vol. J. Phys. IV, Société Française de la Neutronique, 10, 379–423 (2010).

Sharp :

A state of the art ToF Spectrometer

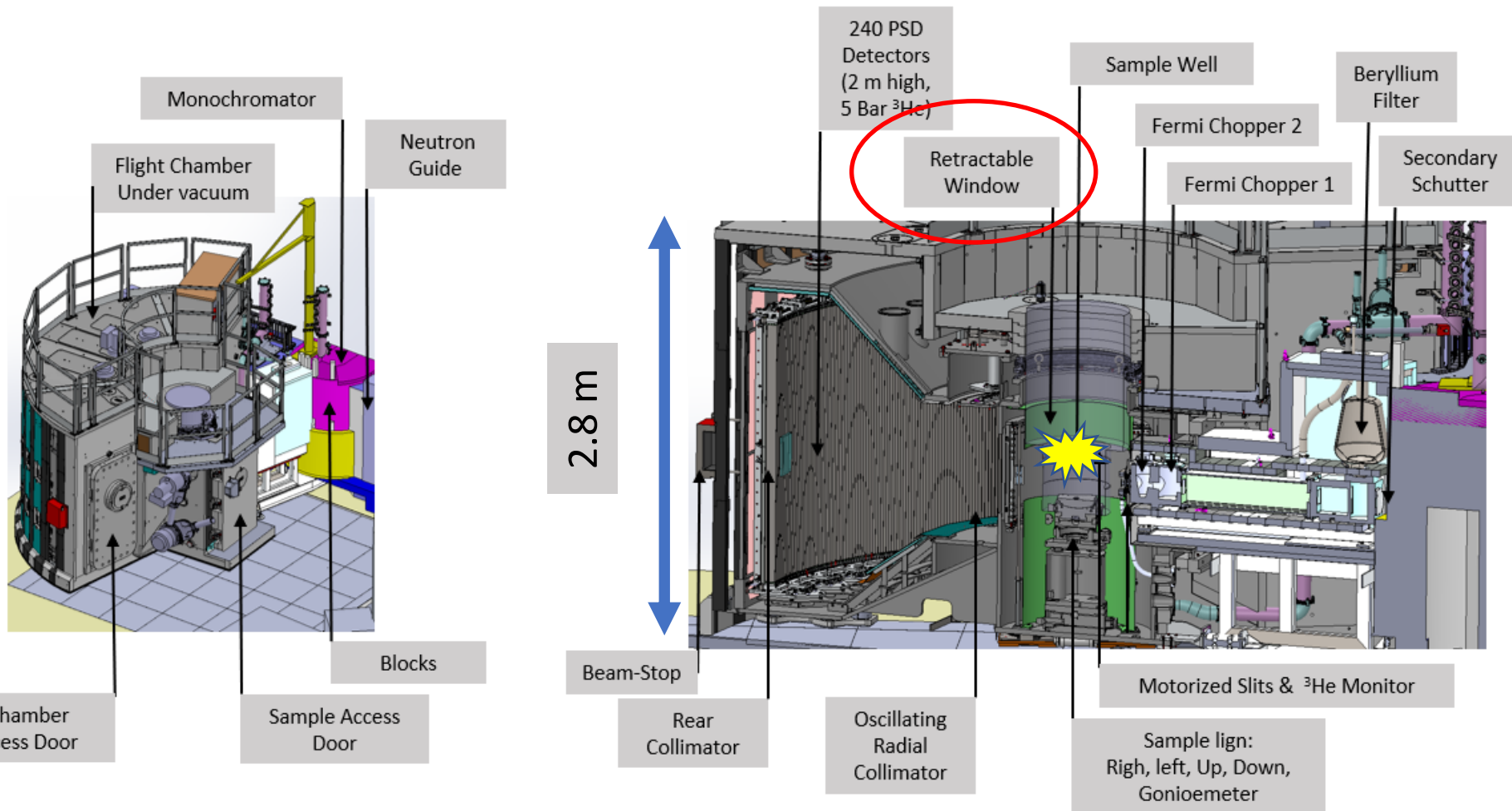

More on « time-of-flight » :

J. Ollivier et J.-M. Zanotti, Diffusion Inélastique de Neutrons par temps de vol. J. Phys. IV, Société Française de la Neutronique, 10, 379–423 (2010).

Detector chamber under vacuum but Sample environment under controlled atmosphere: Retractable Window

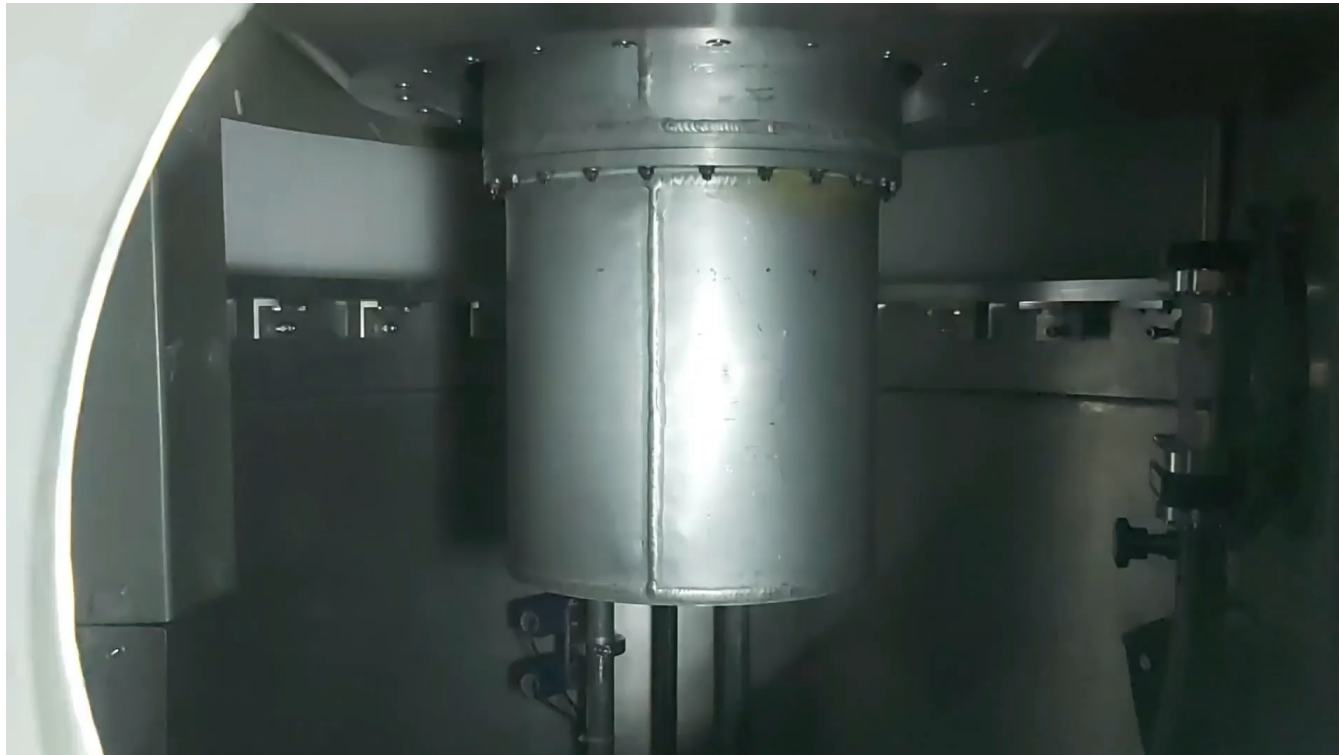
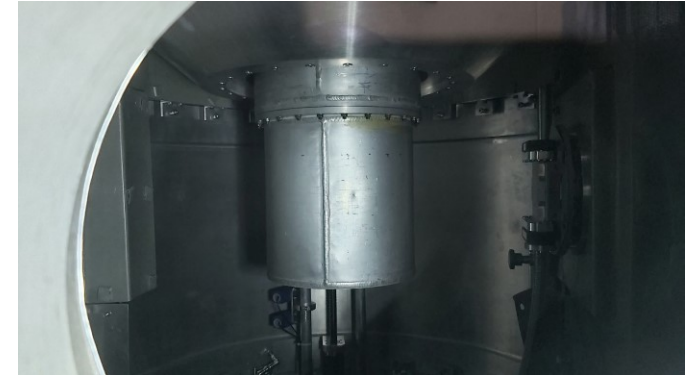
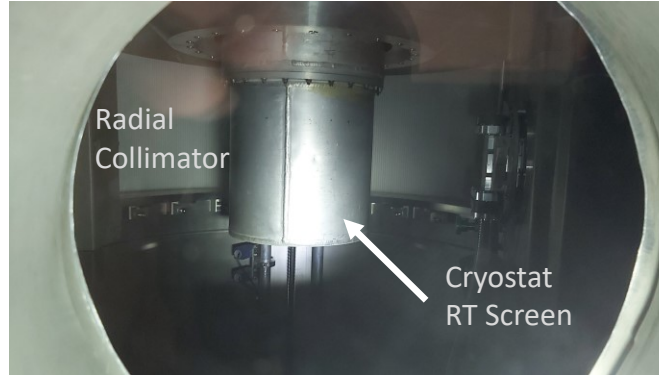
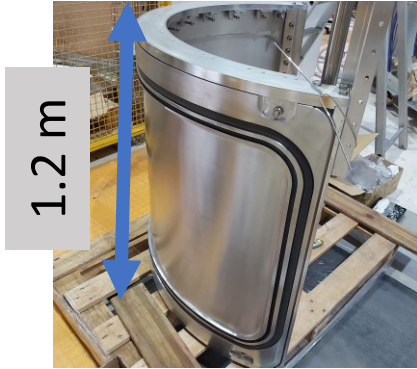

Sharp :

A state of the art ToF Spectrometer

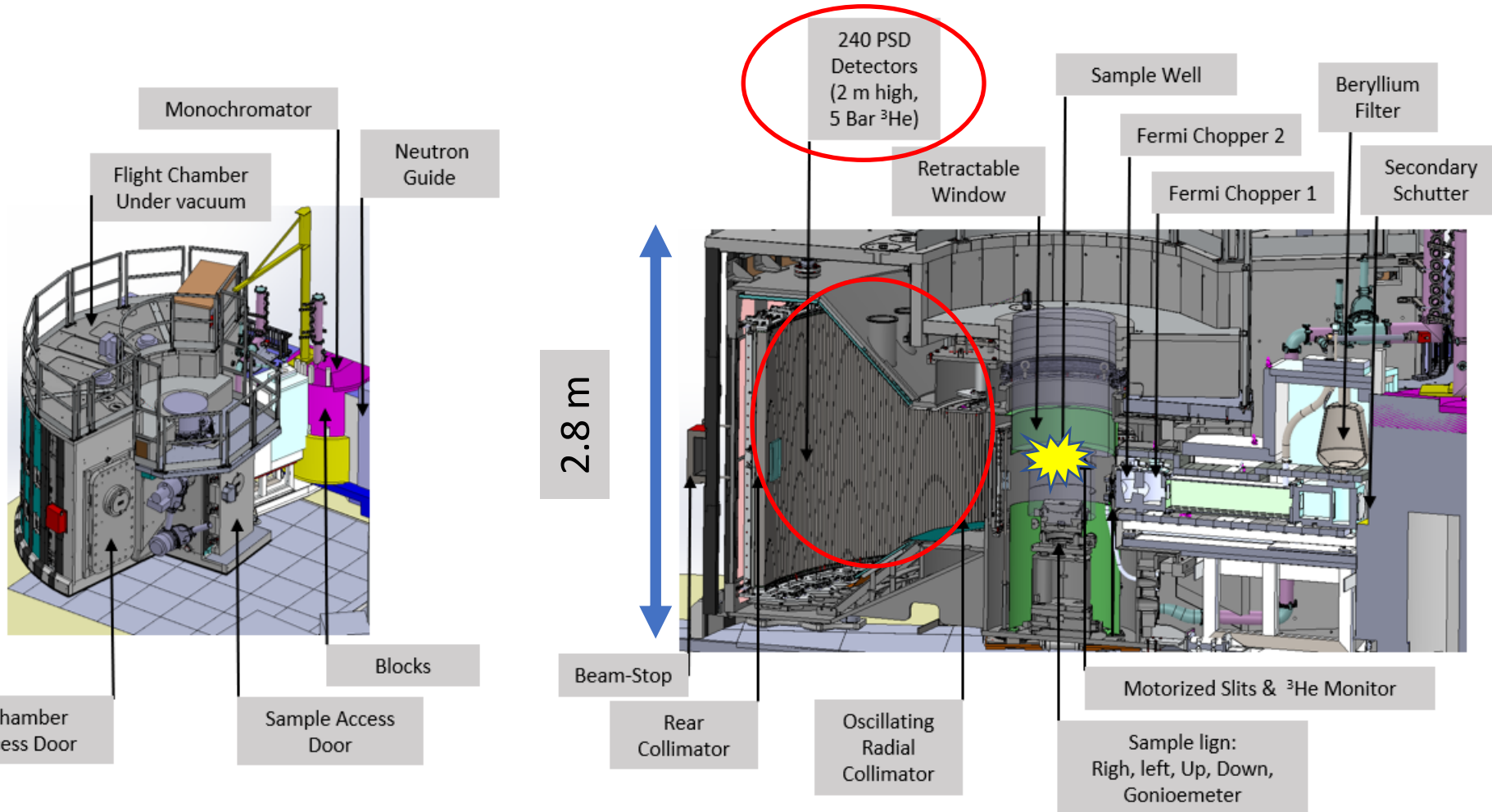

More on « time-of-flight » :

J. Ollivier et J.-M. Zanotti, Diffusion Inélastique de Neutrons par temps de vol. J. Phys. IV, Société Française de la Neutronique, 10, 379–423 (2010).

240 Position Sensitive Detectors 4-144° and Rear Collimator (No cross talks)



30 cm detectors
15-115°
P=3 bar ^3He

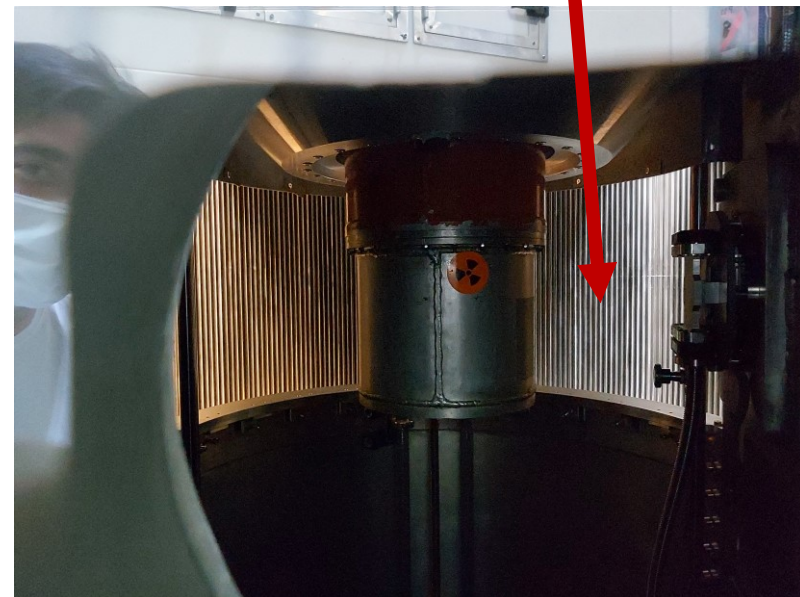
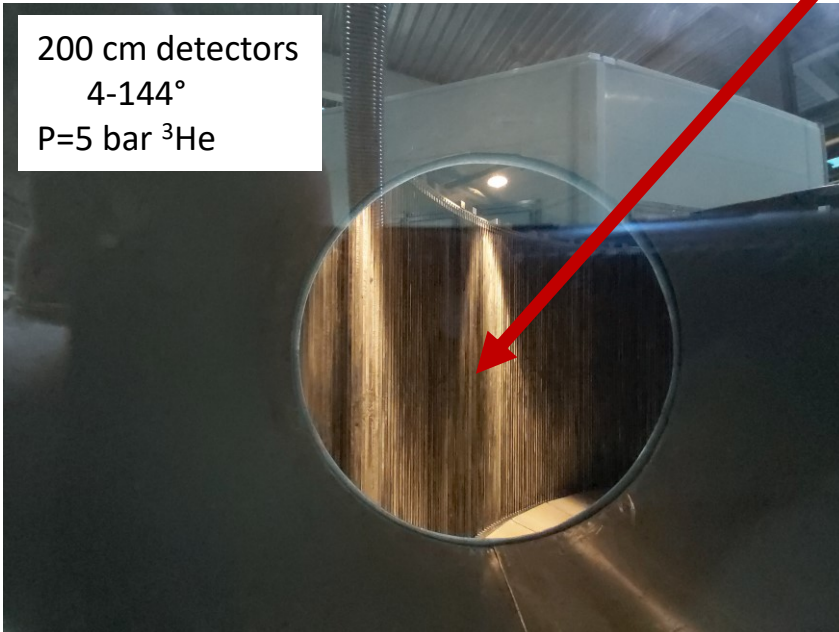
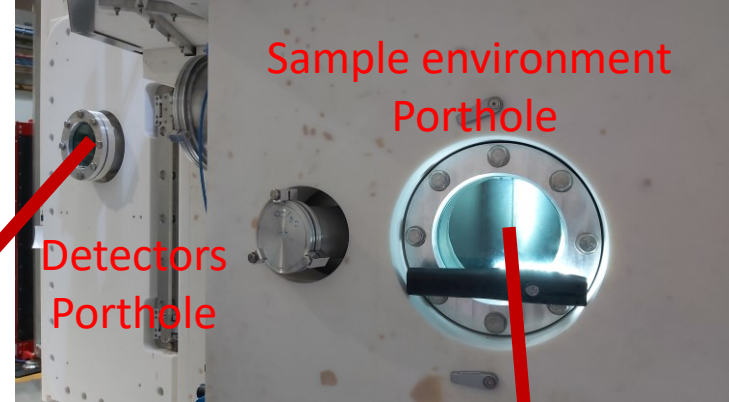
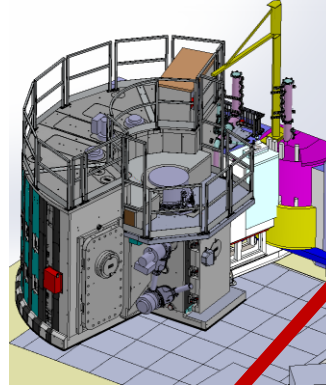

Elementary Mechanisms in Gas Separation using Zeolite Membranes

W. Kellouai, M. Plazanet, P. Judeinstein & B. Coasne

Funding:



October 4-8 2021 (2FDN Beam Time)



Separation of small molecules: CH_4 and CO_2 .

Zeolite separate gazes according to their size, concentration and diffusivity.

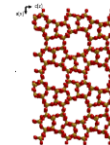

Alumino-silicates

Pores $< 8 \text{ \AA}$

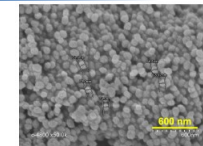

Samples: M. Drobek & A. Julbe, Institut Européen des Membranes, Montpellier

Elementary Mechanisms in Gas Separation using Zeolite Membranes

W. Kellouai, M. Plazanet, P. Judeinstein & B. Coasne

Funding:



October 4-8 2021 (2FDN Beam Time)



Separation of small molecules: CH_4 and CO_2 .

Zeolite separate gases according to their size, concentration and diffusivity.

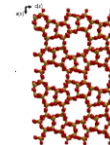

Alumino-silicates

Pores $< 8 \text{ \AA}$

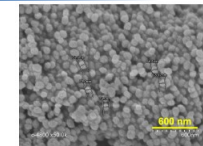

Samples: M. Drobek & A. Julbe, Institut Européen des Membranes, Montpellier

1- Jump diffusion of confined CH_3 (self)

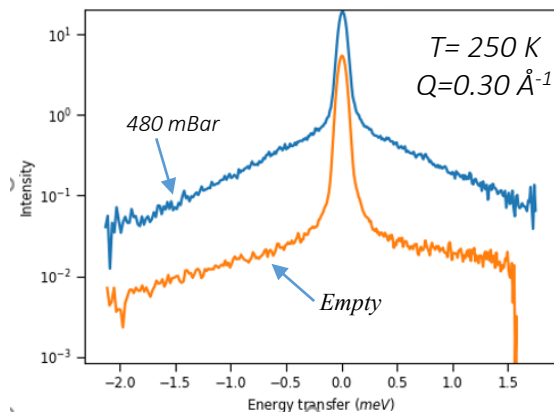

Elementary Mechanisms in Gas Separation using Zeolite Membranes

W. Kellouai, M. Plazanet, P. Judeinstein & B. Coasne

Funding:



October 4-8 2021 (2FDN Beam Time)



Separation of small molecules: CH_4 and CO_2 .

Zeolite separate gases according to their size, concentration and diffusivity.

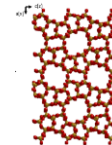

Alumino-silicates
Pores $< 8 \text{ \AA}$

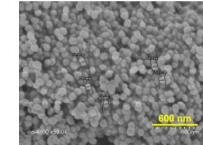

Samples: M. Drobek & A. Julbe, Institut Européen des Membranes, Montpellier

1- Jump diffusion of confined CH_3 (self)

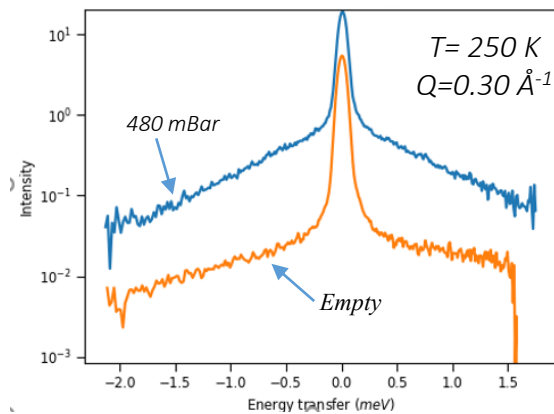

2- Jump diffusion of confined CD_3 (collective)

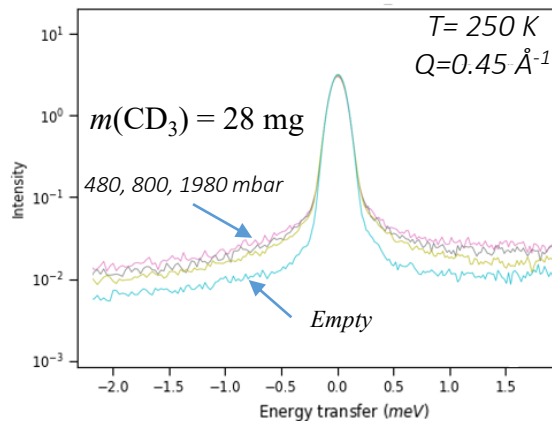

Elementary Mechanisms in Gas Separation using Zeolite Membranes

W. Kellouai, M. Plazanet, P. Judeinstein & B. Coasne

Funding:



October 4-8 2021 (2FDN Beam Time)



Separation of small molecules: CH_4 and CO_2 .

Zeolite separate gases according to their size, concentration and diffusivity.

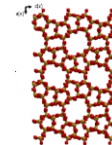

Alumino-silicates
Pores $< 8 \text{ \AA}$

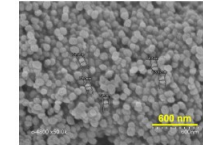

Samples: M. Drobek & A. Julbe, Institut Européen des Membranes, Montpellier

SHARP (240 PSD): Diffraction signal

1- Jump diffusion of confined CH_3 (self)

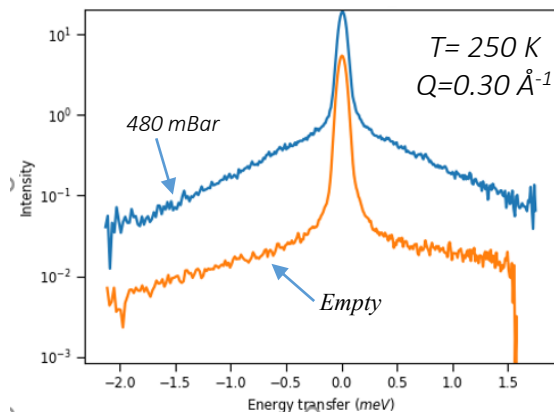

2- Jump diffusion of confined CD_3 (collective)

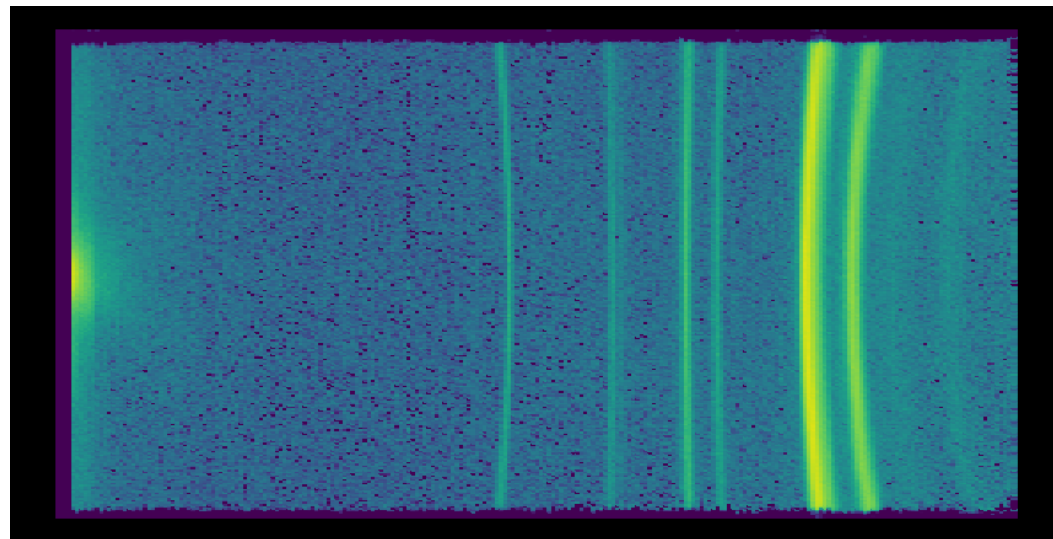
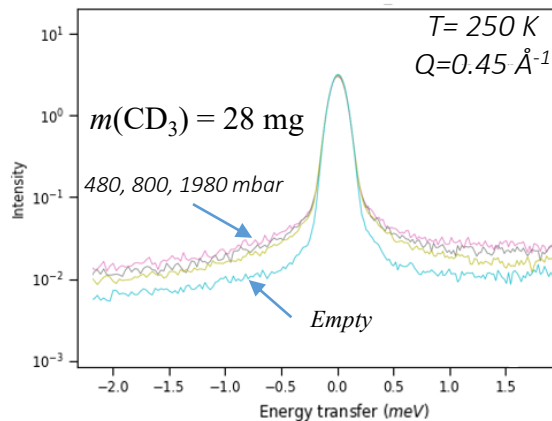

Elementary Mechanisms in Gas Separation using Zeolite Membranes

W. Kellouai, M. Plazanet, P. Judeinstein & B. Coasne

Funding:



October 4-8 2021 (2FDN Beam Time)



Separation of small molecules: CH_4 and CO_2 .

Zeolite separate gases according to their size, concentration and diffusivity.

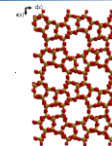

Alumino-silicates

Pores $< 8 \text{ \AA}$

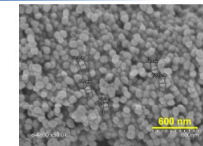

Samples: M. Drobek & A. Julbe, Institut Européen des Membranes, Montpellier

1- Jump diffusion of confined CH_3 (self)

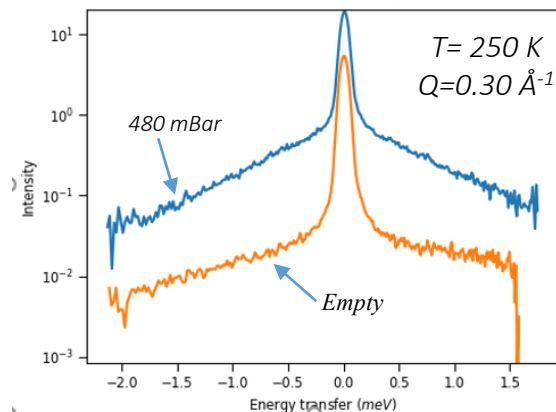

2- Jump diffusion of confined CD_3 (collective)

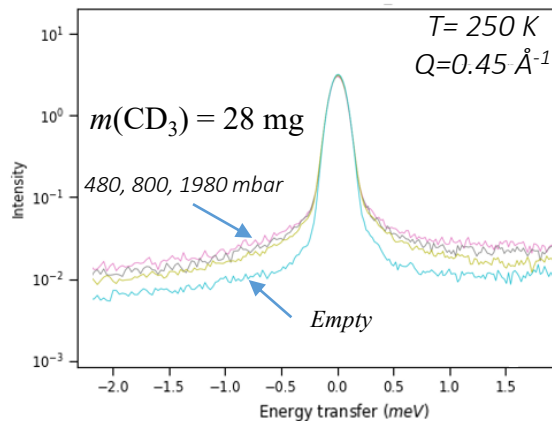

3- Modulation of the Bragg peaks upon CD_4 or CH_4 insertion

SHARP (240 PSD): Diffraction signal

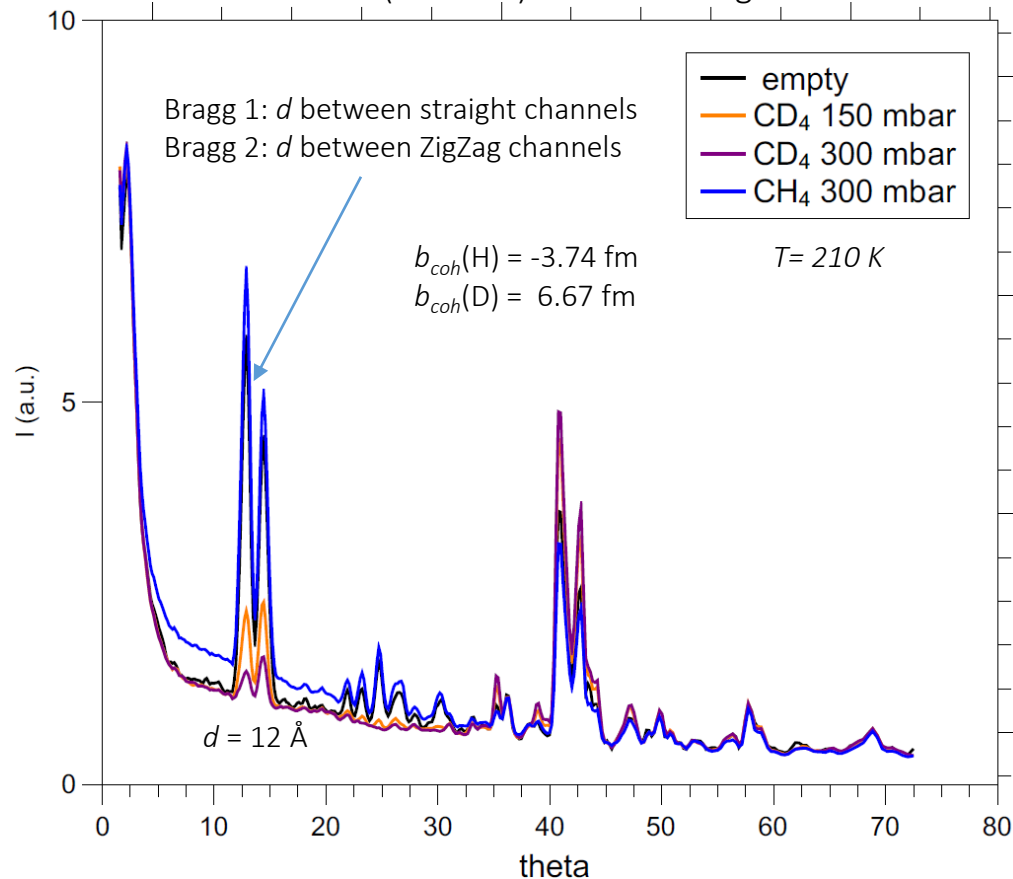

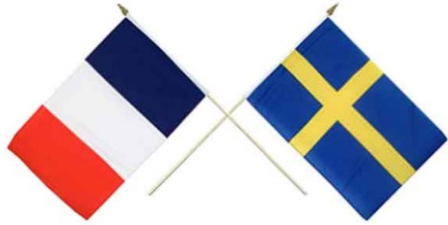

- French-Swedish (CEA - CNRS - Swedish Research Council) agreement for design, construction of neutron spectrometers. Protocol initiated within the framework of the European Spallation Source.



- Conception
- Design
- Building de of the instrument



- Vacuum System of the ToF Chamber
- Detectors Electronics
- Nuclear related regulations and safety



- Funding for sample “lift”

The Actors: professionalism, expertise and involvement

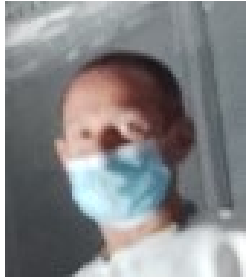

Nicolas Pautrieux



Pablo Abad



Sylvain Rodrigues



Frédéric Legendre



Benoît Homatter



Thomas Robillard



Pascal Lavie

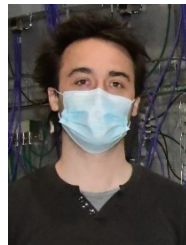

Quentin Berrod



JMarc Zanotti

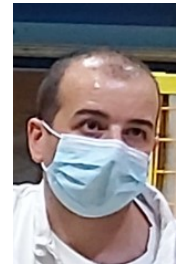

Pascal Lachaume



Franck Cécillon



Christophe Monon



Franck Rey



Emmanuel Courraud



Martin Platz



But also:

- **Bureau d'étude :** L. Didier
P. Permingeat
B. Giroud
- **Hall :** B. Jarry
- **Aménagement :** P. Coggo
- **Mécanique / Usinage :** J. Beaucourt
F. Lapeyre
O. Tessier
- **Détecteurs :** J.-C. Buffet, B. Guéard,
J. Marchal, F. Pinet,
J. Pentenero, S. Cuccaro
- **SCI :** J.-M. Delpierre,
J. Blanc-Pacques,
S. Sallaz-Damaz
- **Vide :** E. Iampasona,
A. Girault
- **Automatismes :** C. Mounier,
B. Sornin
- **Electronique & DAS :** P. Mutti
Y. Le Goc
- **Monochromateur :** P. Courtois
- **Sécurité :** I. Perbet, G. Bonnet
- **Radio-Protection :** F. Rencurel
S. Grimaud
P. Cochet
- **Administratifs :** A. Verdier, S. Mème,
O. Sineau, E. Colas,
P. Combrisson
- **Service Commercial CEA :** A. Rozier,
C. Berthon
- **Planning :** M. Plassard
- **Groupes Spectroscopie :** B. Farago, S. Petit
- **CEA/DRF & IRAMIS :** H. Desvaux, F. Daviaud,
M. Faury, V. Berger
- **CNRS INP & DAS :** E. Lacaze, E. Solal, S. Ravy
- **Management :** E. Eliot, G. Chaboussant,
A. Menelle, C. Alba-Simionesco,
A. Brulet, H. Schober, M. Johnson,
J. Estrade, J. Jestin



From SHARP to SHARP⁺

Future LLB CRG A Instrument

G. Manzin¹ --> S. Roux¹ (Project Engineer)
G. Pastrello¹ (Mechanical Design Responsible)
M. Koza¹ (ILL Scientific Advisor)
J.-M. Zanotti² (Scientific Responsible)

¹ Institut Laue Langevin , Saclay, France
² Laboratoire Léon Brillouin , Saclay, France



Mesot, Janssen, Holitzner & Hempelmann, J. Neutron Research, 3, 293-310 (1993).

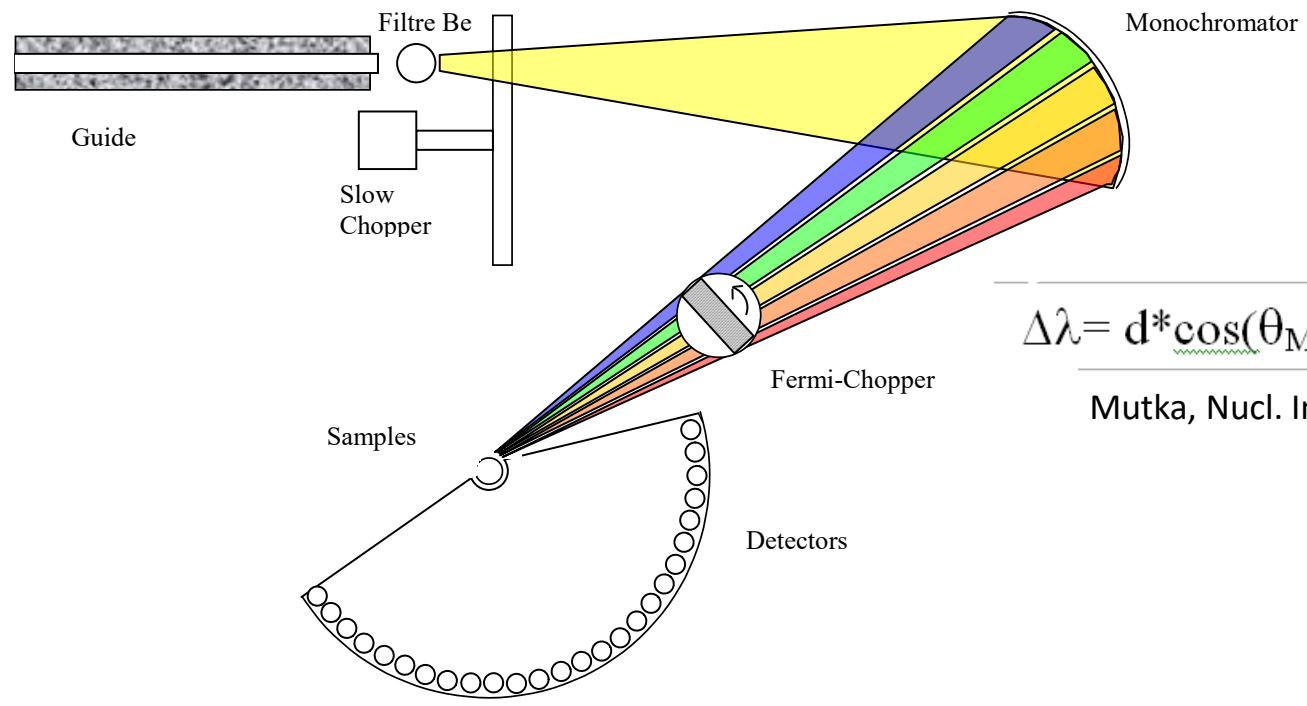

$$\Delta\lambda = d \cdot \cos(\theta_M) \cdot W \cdot \sin(\theta_M) \cdot \left| \frac{1}{d_{GM}} - \frac{1}{d_{ME}} \right|$$

Mutka, Nucl. Inst. & Meth. A, 338, 144-150 (1994).

● $d_{GM} \neq d_{MS}$: **Time Focusing (TF)**

---> large λ band: **High flux**

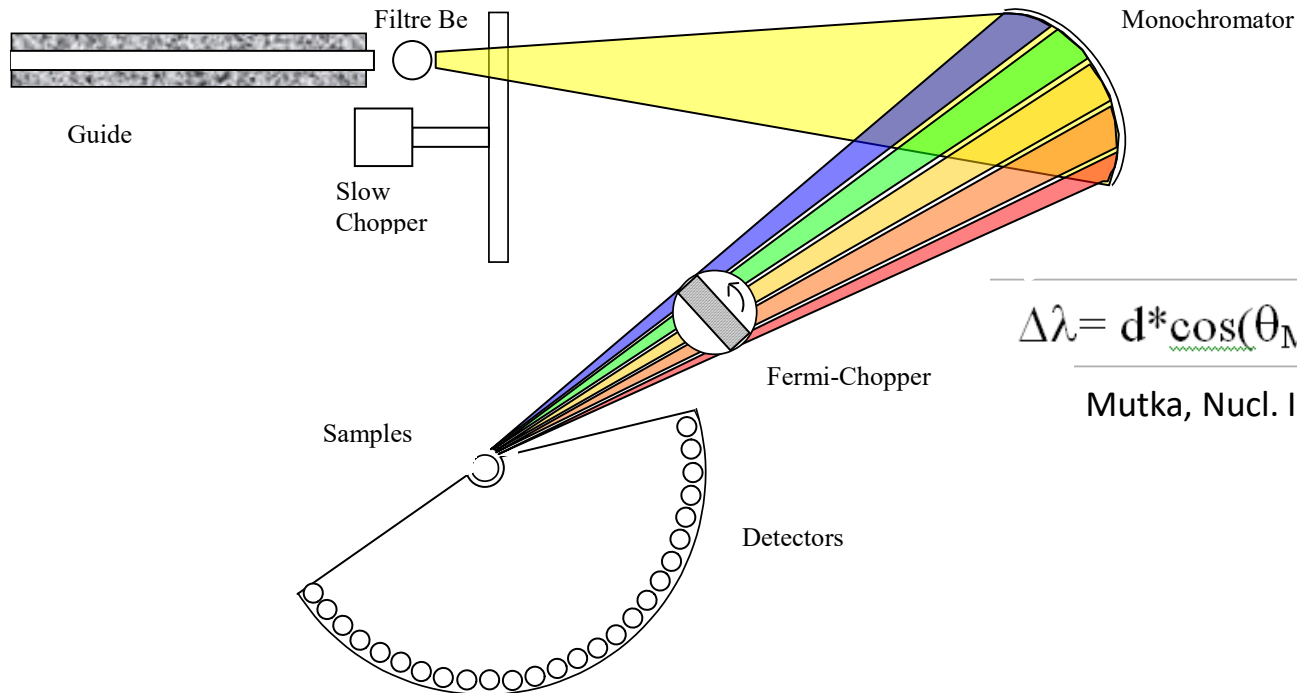

$$\Delta\lambda = d \cdot \cos(\theta_M) \cdot W \cdot \sin(\theta_M) \cdot \left| \frac{1}{d_{GM}} - \frac{1}{d_{ME}} \right|$$

Mutka, Nucl. Inst. & Meth. A, 338, 144-150 (1994).

- $d_{GM} \neq d_{MS}$: **Time Focusing (TF)** ---> large λ band: High flux
- $d_{GM} = d_{MS}$: **Monochromatic Focusing (MF)** ---> narrow λ band: Good resolution on an extended ω range

Time focusing (IN6 like)

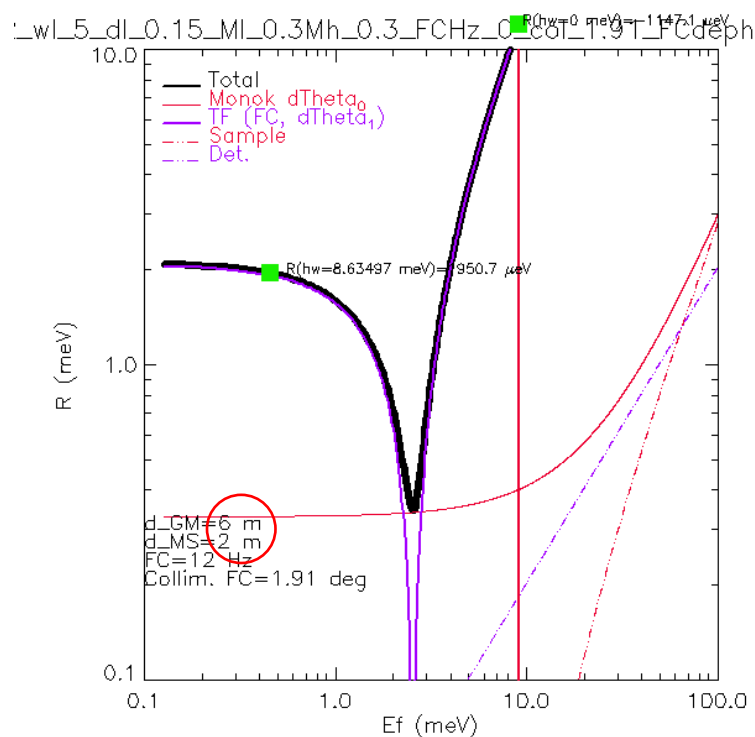

Monochromatic focusing (IN5 like)

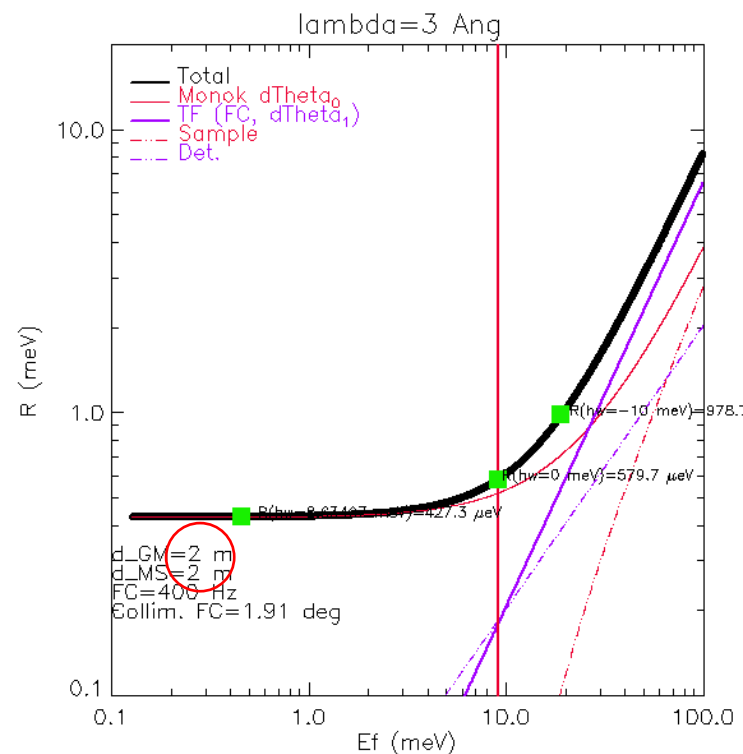

NB: Distance Monochromator to sample = 2 m

- Distance guide to monochromator: 2 m

--- > **Monochromatic Focusing**

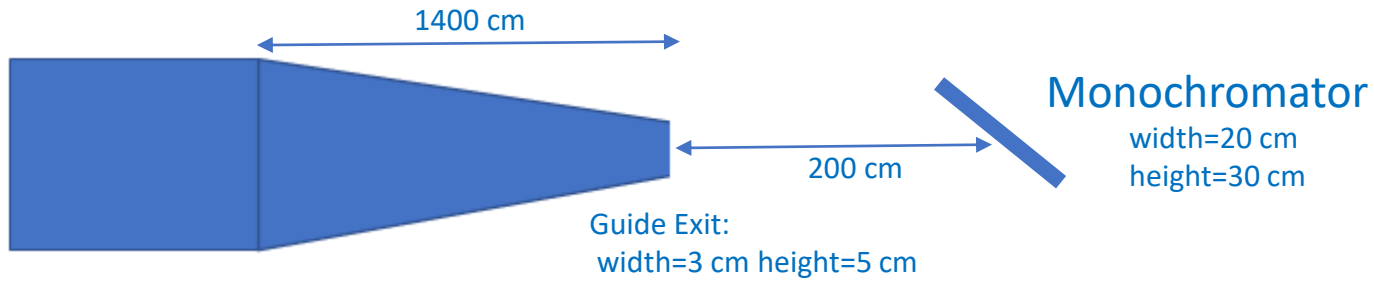

NB: Distance Monochromator to sample = 2 m

- Distance guide to monochromator: 2 m

--- > **Monochromatic Focusing**

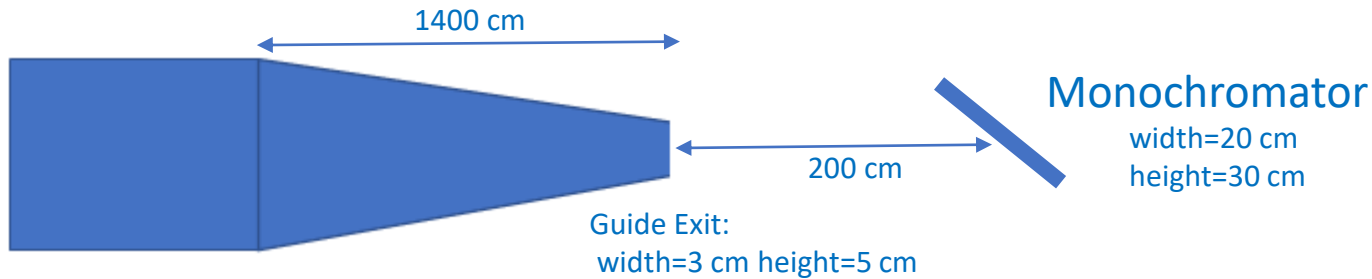

- Set by a 4.5 m retractable guide section at the end of the 14 m elliptic guide: distance monochromator to sample: $4.5+2 = 6.5$ m -- > **Time Focusing**

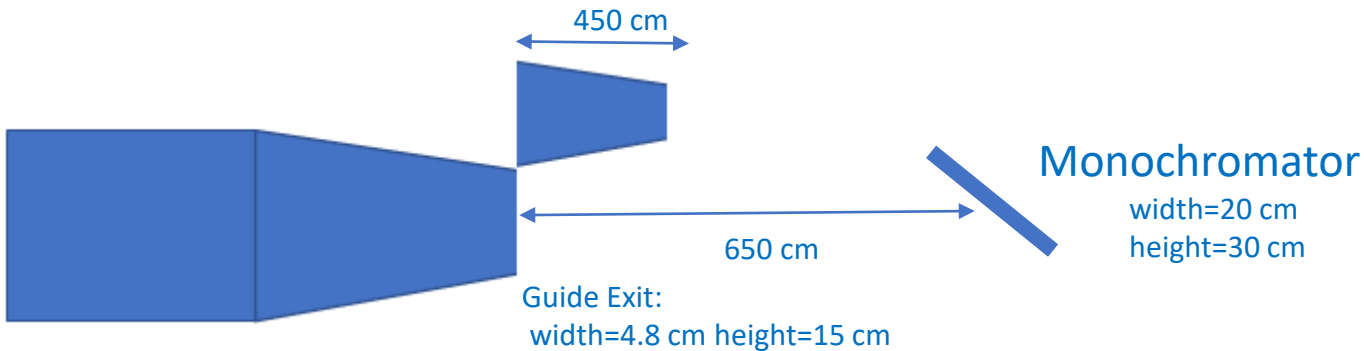

NB: The length of the retractable section has been optimized on a FC speed criterium (ratio).

NB: Distance Monochromator to sample = 2 m

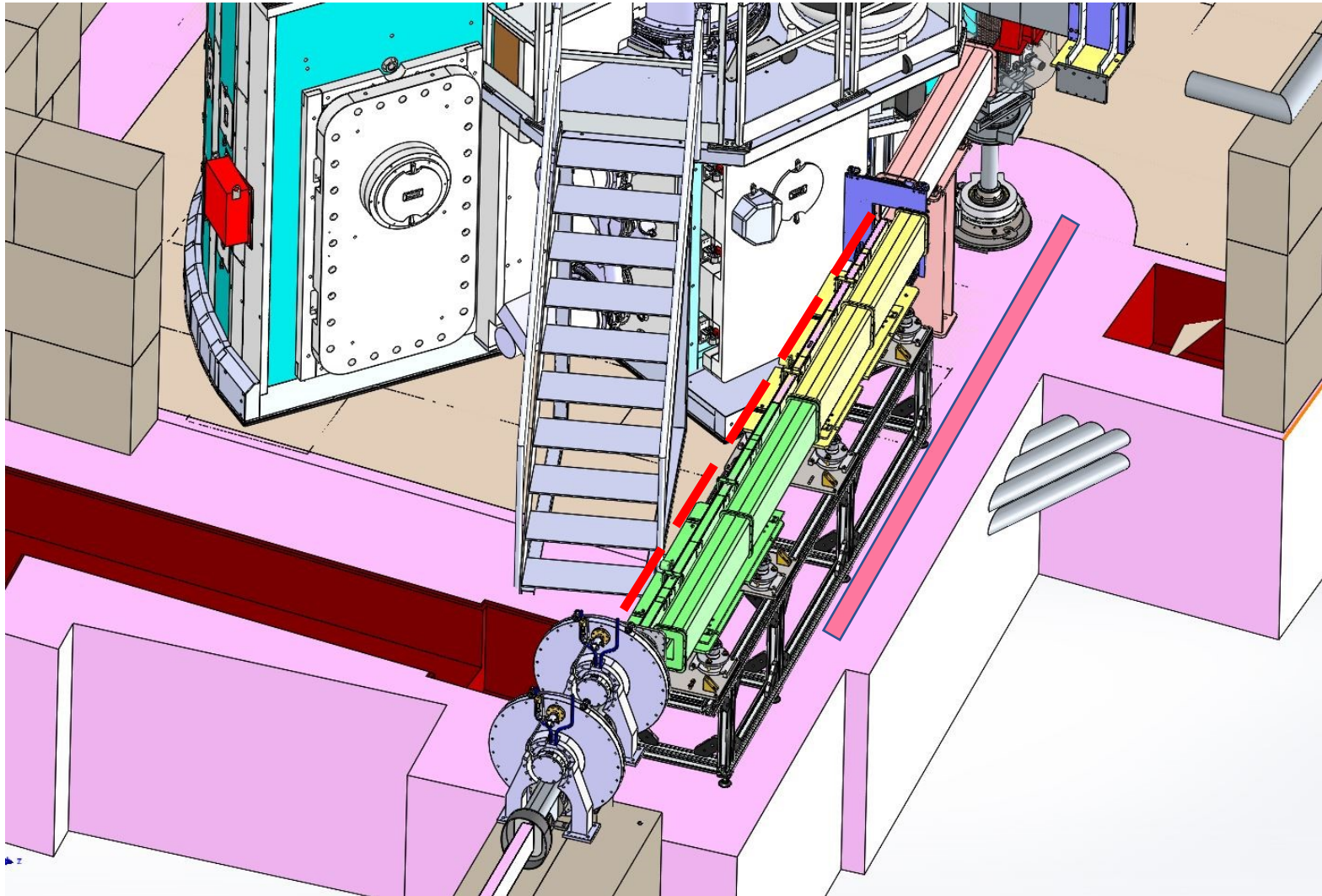

Courtesy Sébastien NICOLLE, SEI@ILL

IN6-Sharp
Scientific Activity
2018 -2020

College	ILL beam time (days)	%	CRG beam time (days)	%	Total	Total
#1: Applied Materials	6	100%	0	0%	6	2%
#4: Magnetic excitations	29	33%	59	67%	88	29%
#6: Liquids/Glasses	21	30%	48	70%	69	23%
#7: Spectroscopy in solid state physics & Chemistry	75	68%	36	32%	111	36%
#8: Biology	0	0%	5	100%	5	2%
#9: Soft Matter	9	33%	18	67%	27	9%
Total	140	46%	166	54%	306	100%

2FDN community: need for high resolution i.e. $\lambda > 6.0 \text{ \AA}$

IN6-Sharp Diffraction Test 26/09/2020

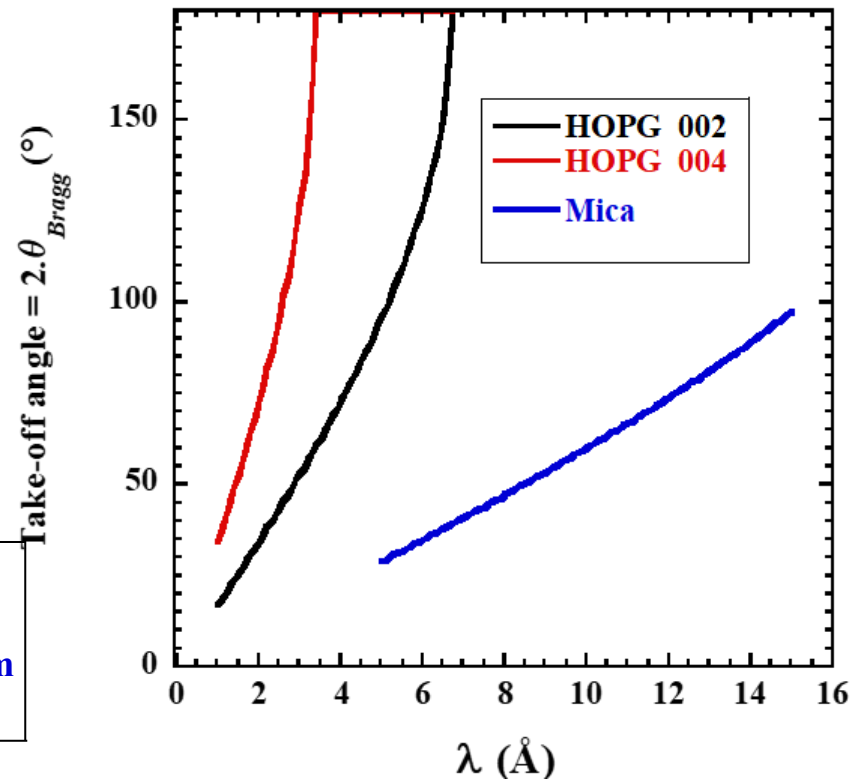
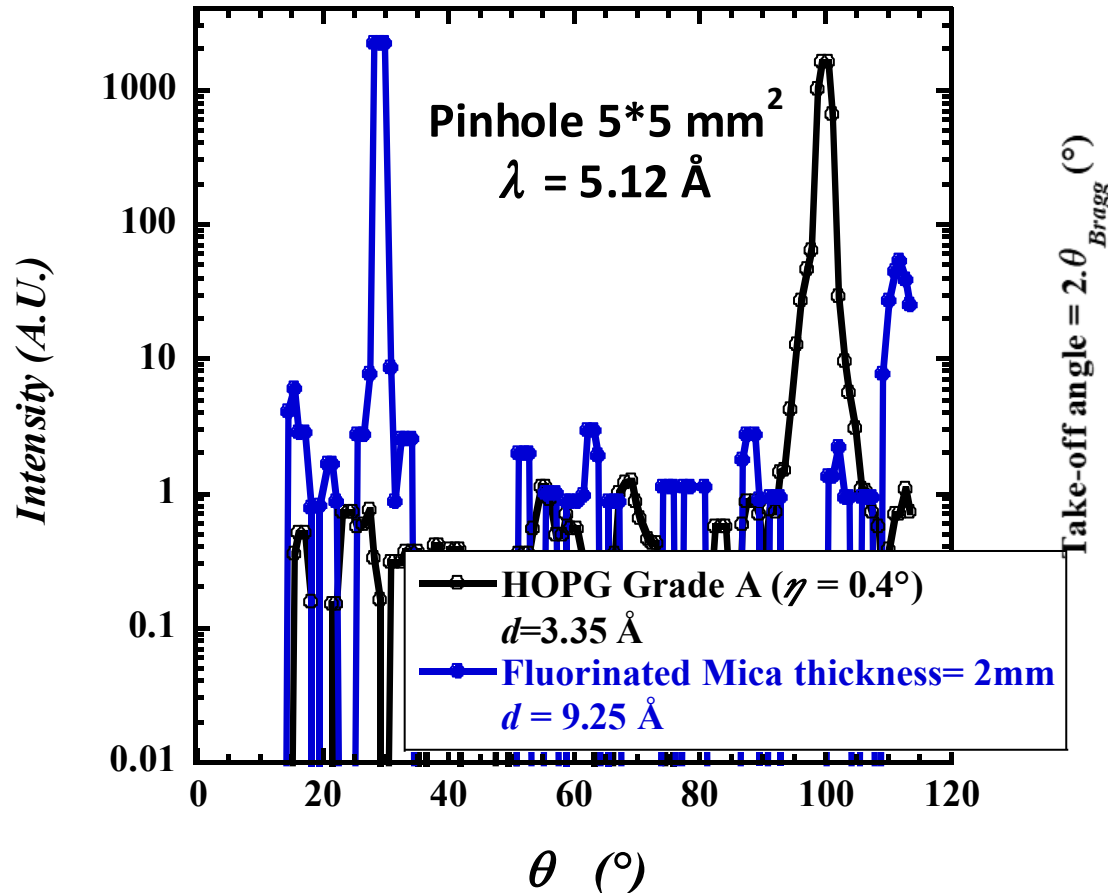

- Pinhole diffraction (IN6-Sharp) : Expected Bragg peak detected at $d = 9.25 \text{ \AA}$
- No detectable natural mosaicity. Confirmed by P. Courtois (Monok Service ILL) test.
- First Xray Reflectivity test P. Courtois (Monok Service ILL) good.
- SHARP+ funded by ILL: so far a second monochromator not in the scope.

IN6: a cold time-of-flight inelastic spectrometer "time focusing"

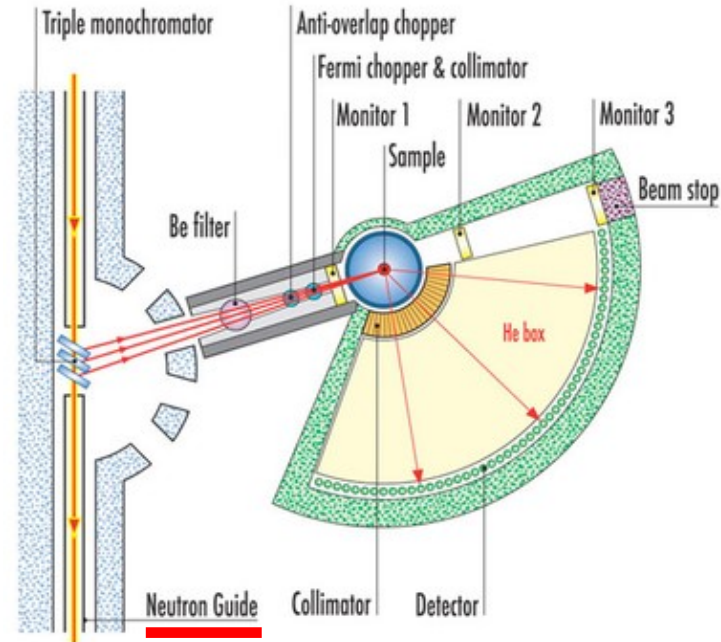
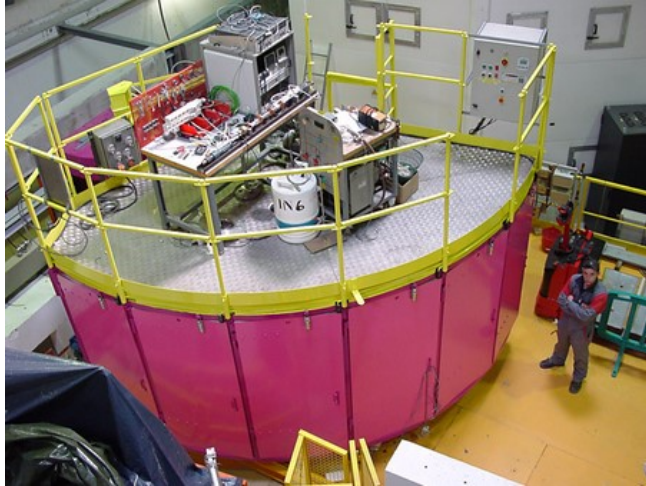

1- Sharing the H15 guide with D7 and D11:
not a guide end: 4 wavelengths.

4 incident wavelengths

Incident wavelength	Energy Resolution
4.1 Å	170 μeV
4.6 Å	120 μeV
5.1 Å	70 μeV
5.9 Å	50 μeV

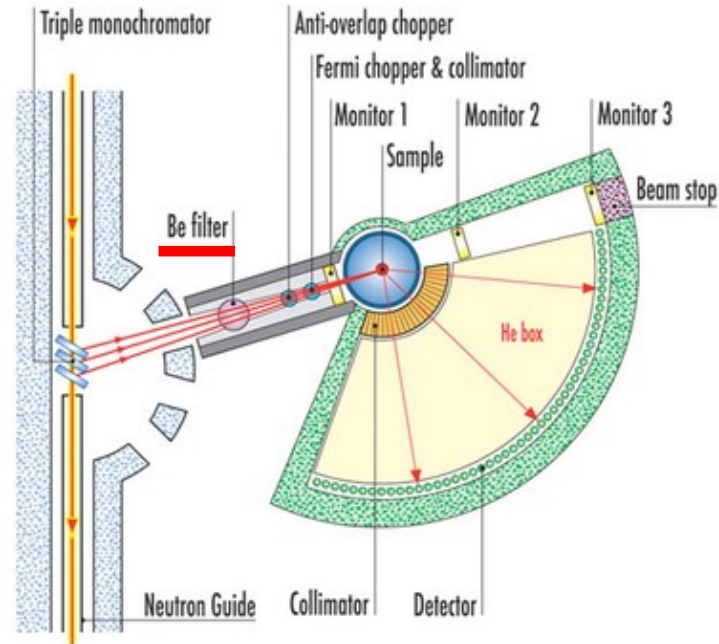
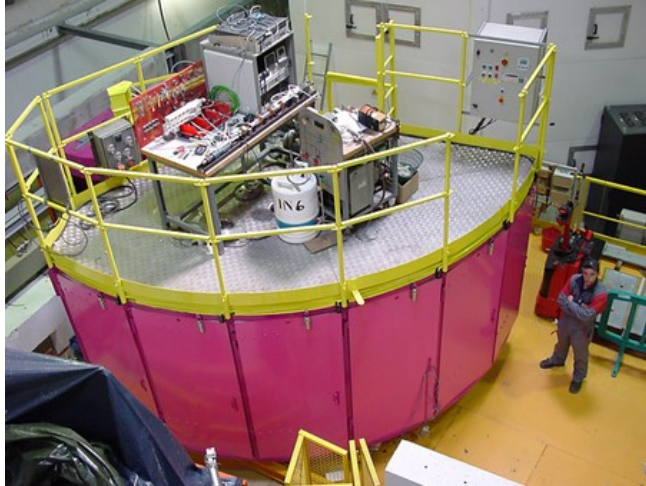

2- Beryllium Filter (T= 77 K)

1- Sharing the H15 guide with D7 and D11:
not a guide end: 4 wavelengths.

4 incident wavelengths

Incident wavelength	Energy Resolution
4.1 Å (not below)	170 μeV
4.6 Å	120 μeV
5.1 Å	70 μeV
5.9 Å	50 μeV



Design to optimize Flux and offer extended Incident lambda: No Beryllium filter (save 15-20% flux)

Guide End: 3 Disk chopper cascade to remove harmonics

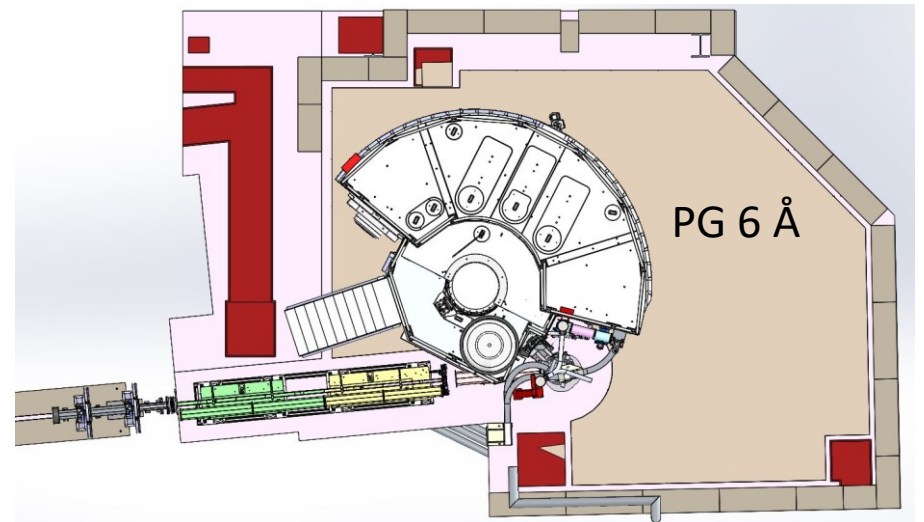
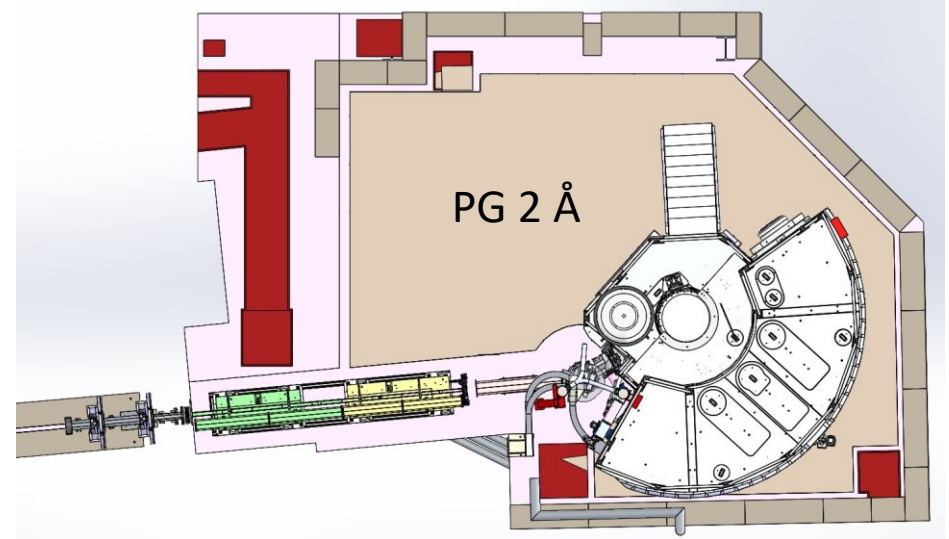
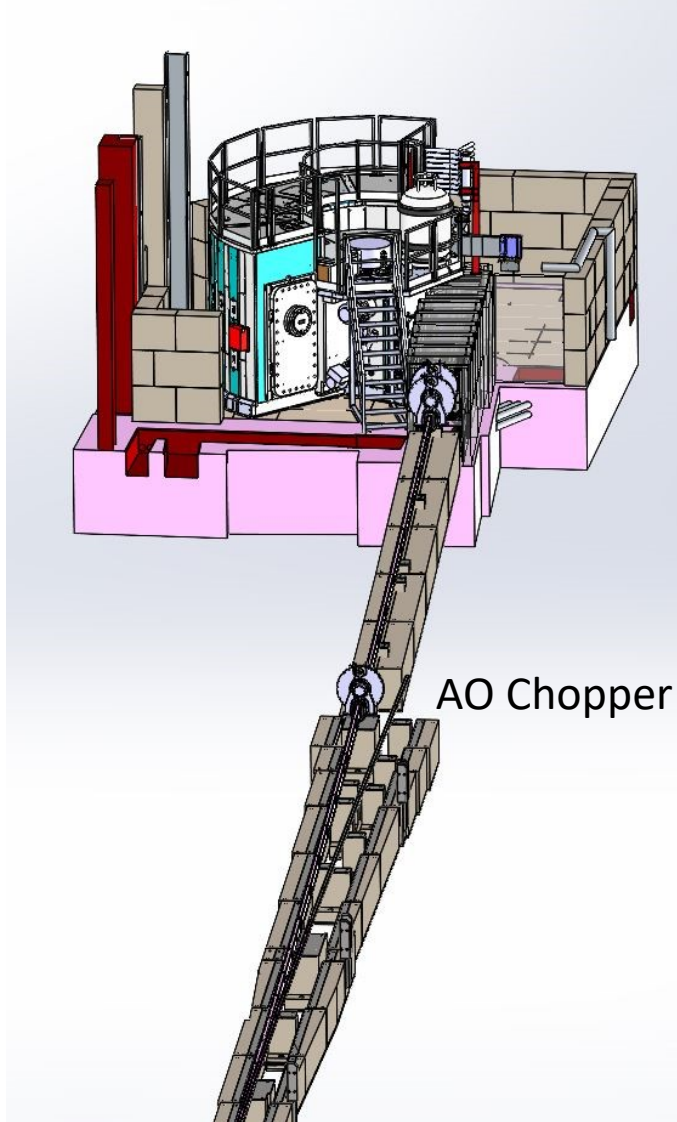

Extended Q and resolution range

Compromise at will between flux and resolution

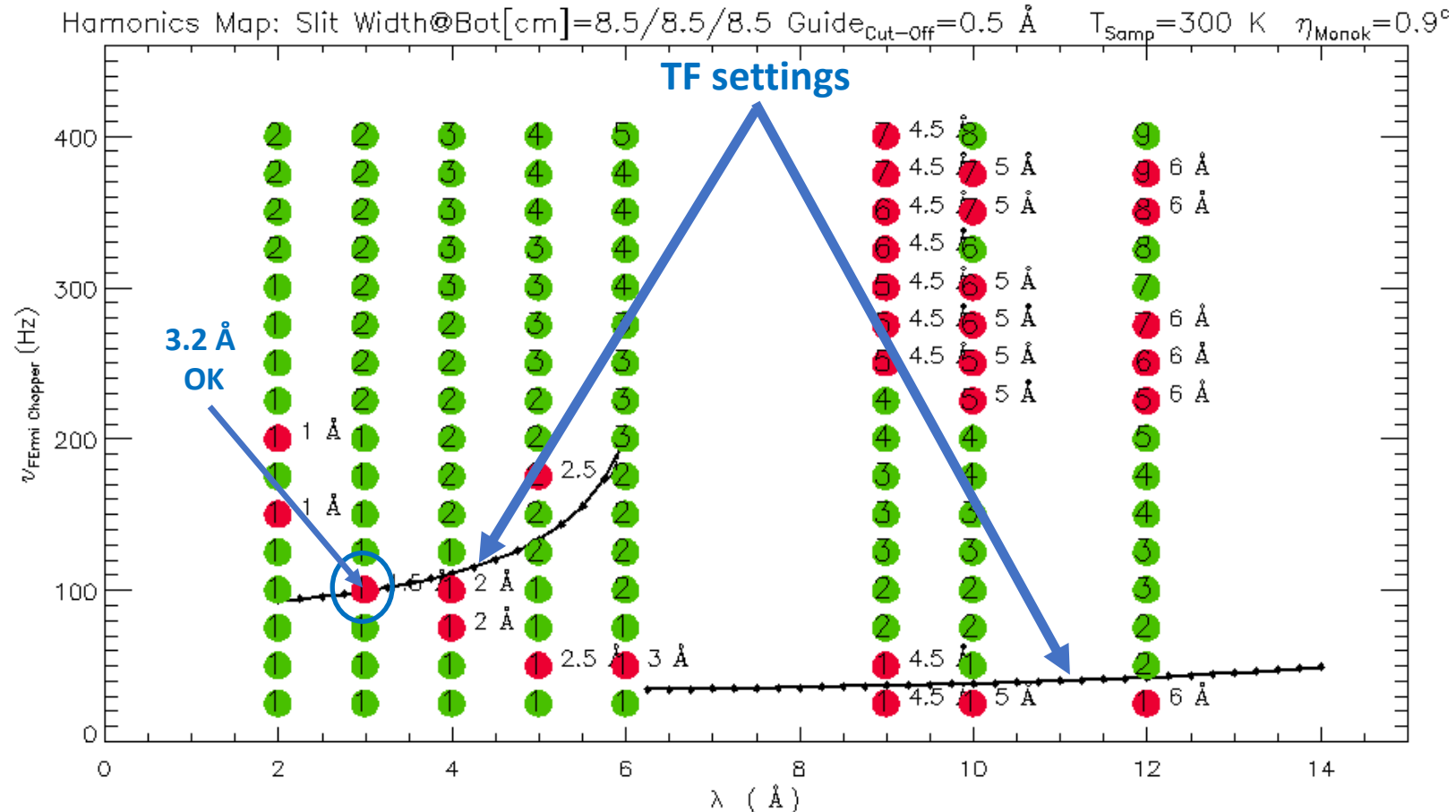

/home/ds/zanottiim/McStas/20210403_size_fermi/Harmonic_study_14072021_sw_8.5_8.5_8.5/

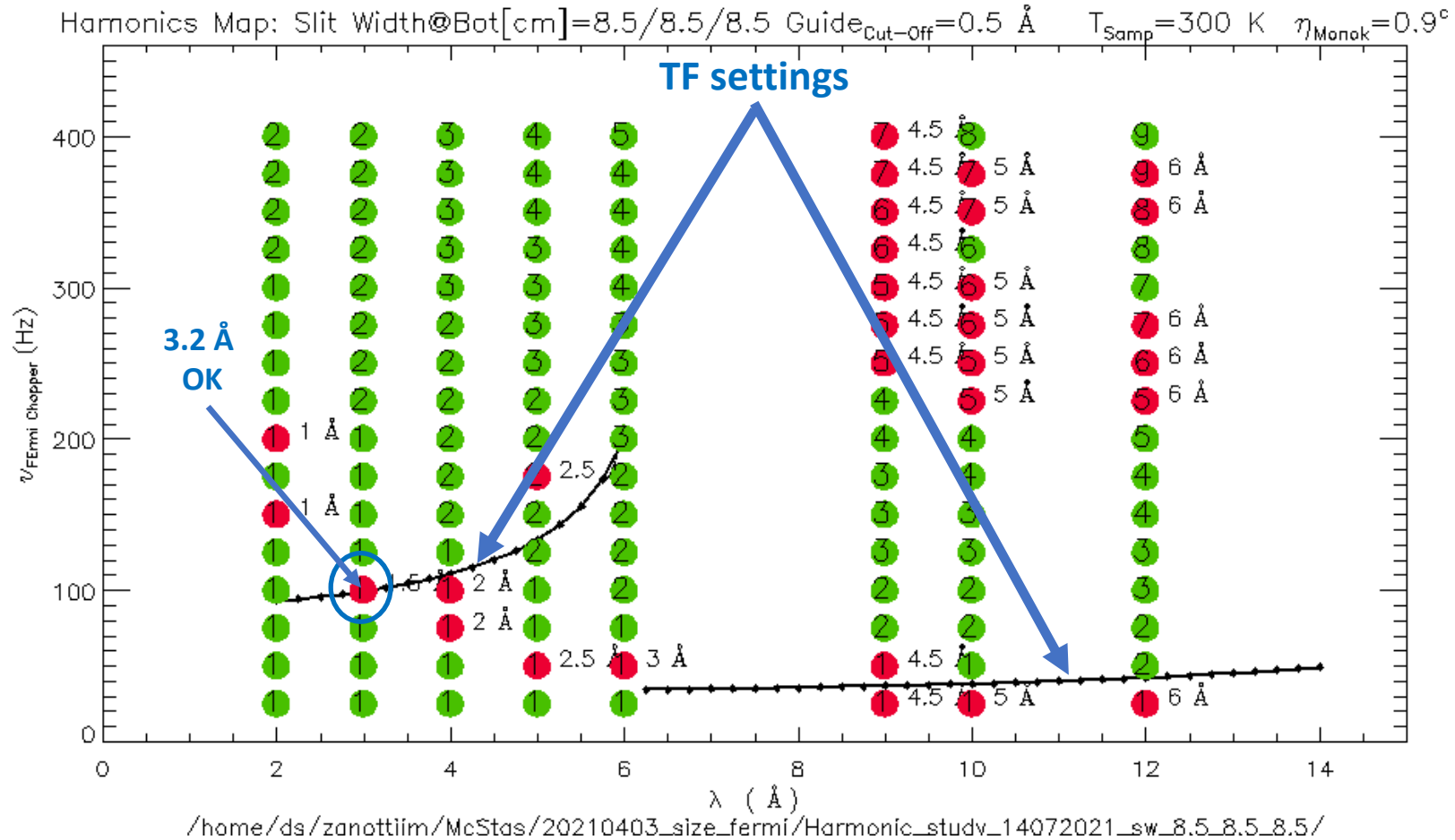

Monochromatic Focusing mode key for experiments at $\lambda > 6 \text{ \AA}$
i.e. reach high resolution

1- McStas model seems quite accurate.
Here McStas points (●, ●) vs analytical calculation of $R(\omega)$.

2- Resolution well reproduced so flux estimate meaningful.

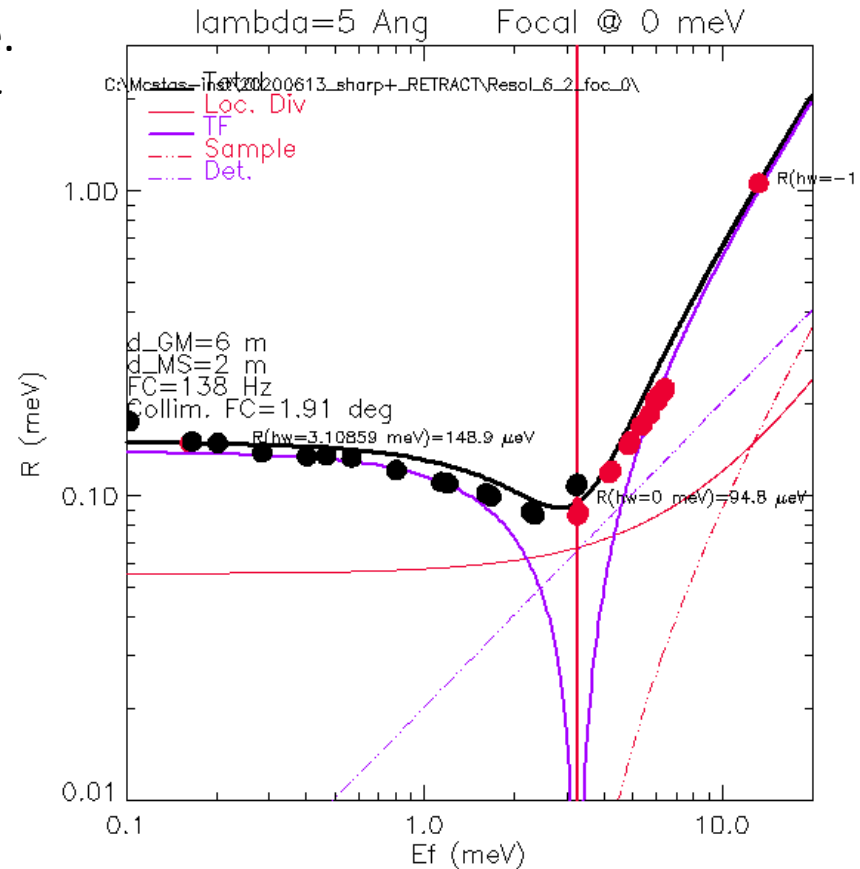

The future of SHARP: SHARP⁺

Counting rate at least 10 compared to IN6

An “Hybrid” Spectrometer with a 4.5 m retractable guide nose

- 1- Nose OUT : “IN6 like” (Time-Focusing Mode) --> Improved energy resolution on a narrow desired energy range.
- 2- Nose IN : “IN5 like” (Monochromatic Mode) --> constant energy resolution on extended energy transfer range.

Monochromatic Focusing ("IN5 like")

λ (Å)	Sample Temp. (K)	v_{FC} (Hz)	AO Chopper Ratio	R (μeV)	Flux @ Samp. (10^5 n/cm ² /s)	Solid Angle ratio	P(³ He) Gain	Xtal Reflectivity	T_{Windows}	Counting Rate (10^5 n/cm ² /s)
5	30	5	1	116	5.87	3.65	1.05	0.88	0.95	18.8
5	300	5	2	116	2.88	3.65	1.05	0.88	0.95	9.2

Time Focusing ("IN6 like")

λ (Å)	Sample Temp. (K)	v_{FC} (Hz)	AO Chopper Ratio	R (μeV)	Flux @ Samp. (10^5 n/cm ² /s)	Solid Angle ratio	P(³ He) Gain	Xtal Reflectivity	T_{Windows}	Counting Rate (10^5 n/cm ² /s)
5	30	133	1	99	4.73	3.65	1.05	0.88	0.95	15.2
5	300	133	2	99	3.6	3.65	1.05	0.88	0.95	11.5
5	300	114	1	107	5.68	3.65	1.05	0.88	0.95	18.2

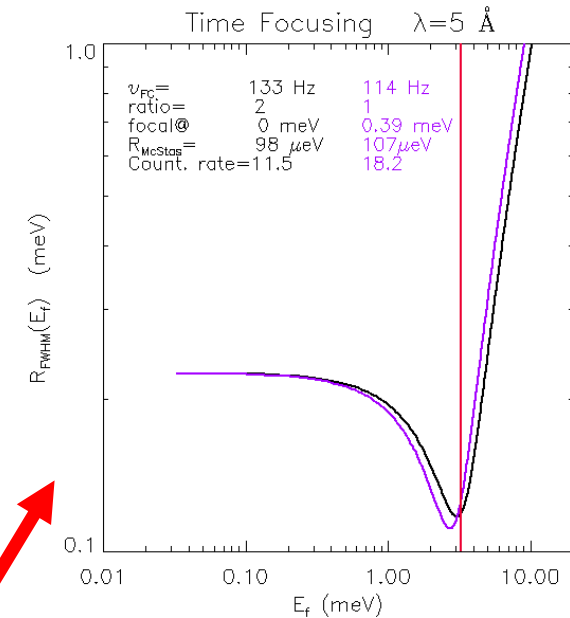

The future of SHARP: SHARP⁺

Counting rate at least 10 compared to IN6

Focusing Monochromators (20*30 cm ²)	/	Wavelength	/	Energy Resolution
HOPG	/	2.0 - 6.3 Å	/	1.20 meV – 0.070 meV
Fluorinated Mica (project)	/	6.0 - 12 Å	/	0.12 meV – 0.025 meV
Fermi Speed		50-400 Hz		

An **Hybrid²** Spectrometer with a 4.5 m retractable guide nose

- 1- Nose OUT : “IN6 like” (Time-Focusing Mode) --> Improved energy resolution on a narrow desired energy range.
- 2- Nose IN : “IN5 like” (Monochromatic Mode) --> constant energy resolution on extended energy transfer range.

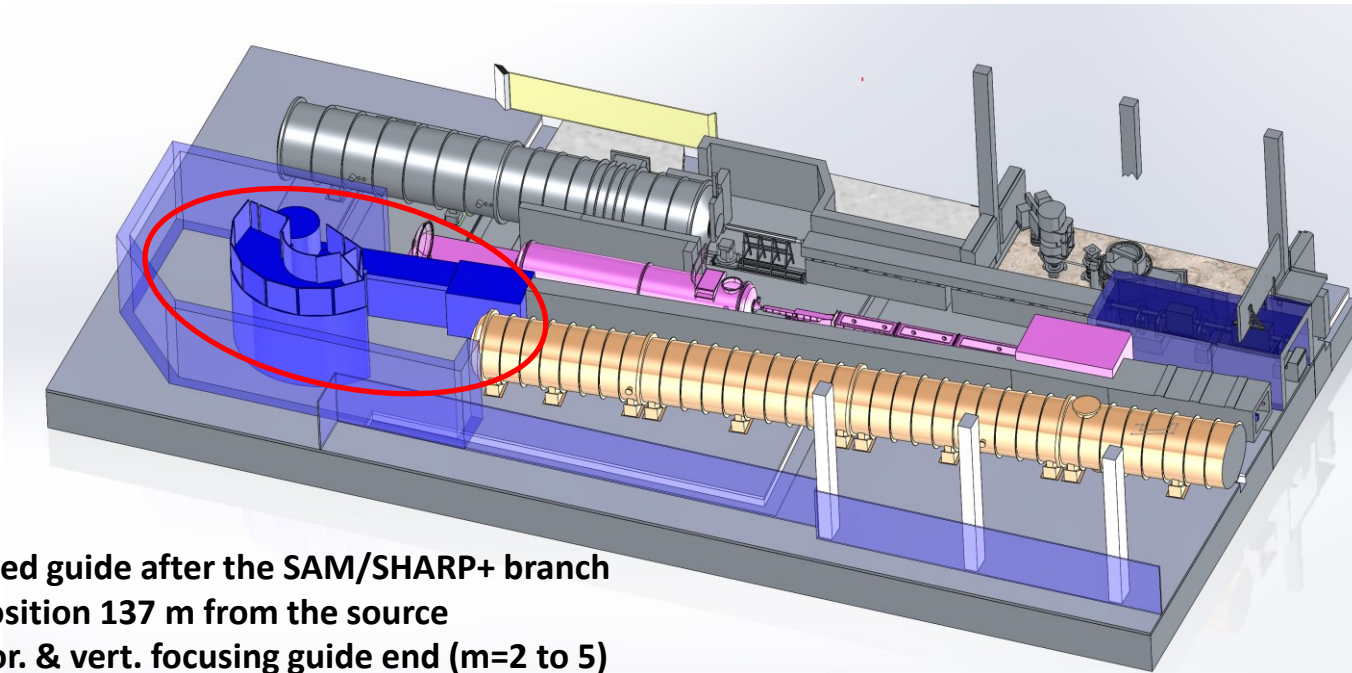

- * A 60 m dedicated guide after the SAM/SHARP+ branch
- * A guide-end position 137 m from the source
- * Elliptic 14 m hor. & vert. focusing guide end (m=2 to 5)
- * No Be Filter but instead 3 anti-harmonics 200 Hz disk choppers cascade
- * Brand new 400 Hz Fermi Chopper

March 24 2022



April 2 2024

