

Introduction

I. Electronic scattering (a brief introduction)

II. Quantum Shot noise

III Shot Noise and Interactions:

→ **IV. Shot noise: *the* tool to detect entanglement**

1. Entanglement with the Fermi statistics

2. Coincidence measurements using shot noise correlations

V. Shot noise and high frequencies

IV. 1. Entanglement with the Fermi statistics

some definitions for qubits

single qubit: $|A\rangle = \alpha|0\rangle + \beta|1\rangle$

two-qubit

$$|B\rangle \otimes |A\rangle = \alpha_{ij} |i\rangle |j\rangle \quad i, j = 0,1$$

two-qubit Bell's state

$$B_{00} = \frac{1}{\sqrt{2}} (|00\rangle + |11\rangle) \quad (\text{Bell's states})$$

$$B_{01} = \frac{1}{\sqrt{2}} (|01\rangle + |10\rangle)$$

$$B_{10} = \frac{1}{\sqrt{2}} (|00\rangle - |11\rangle)$$

$$B_{11} = \frac{1}{\sqrt{2}} (|01\rangle - |10\rangle)$$

non-classical correlations in a Bell's state

$$B_{00} = \frac{1}{\sqrt{2}} (|00\rangle + |11\rangle)$$

measure 0 on qubit A projects qubit B on 0
measure 1 on qubit A projects qubit B on 1

correlations are stronger than any classical correlation (there is no hidden parameter shared by the qubits which carries information on their correlation). Bell's inequalities on correlation measurements performed on various configurations assume this, and so are violated for Bell's states.

We will see that the Fermi sea 'naturally' generates such non-classical states.

flying qubits

two fundamental approaches for coding qubits

- **two levels** :
gates are operated dynamically (rf, photons...)

NMR spin, atoms, Quantum Dots, Super-conducting qubits, ...

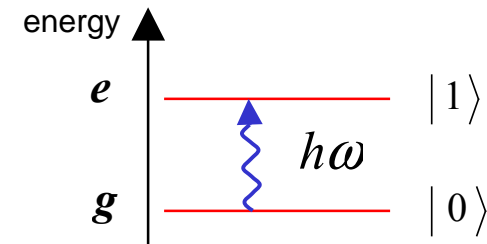

- **two modes** :
static gates are pre-defined

polarized photons

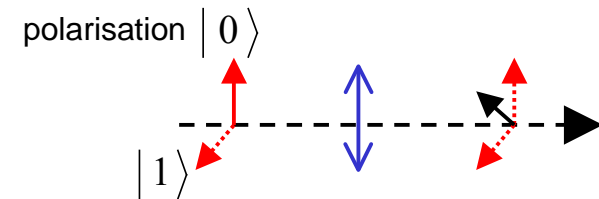

electron in **ballistic** quantum conductors show a strong analogy with photons in optical medium:

quantum bricks are available to realize complex **quantum gates**:

- beam splitter, Fabry-Pérot, Mach-Zehnder interferometer
- phase shift induced by a gate or a static magnetic field

Fermi statistics gives **noiseless electron sources** (voltage bias contact) (unlike photon sources) on demand **single electron sources** like single photon sources realizable using quantum dots

entanglement without interactions

just look at the magic properties of the Fermi sea

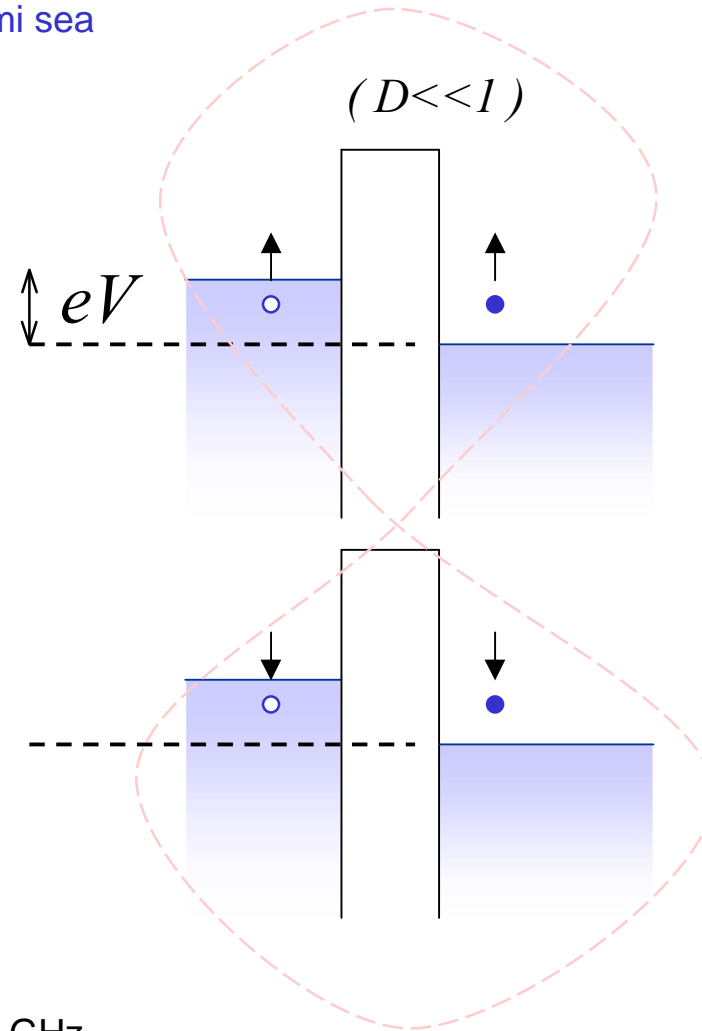
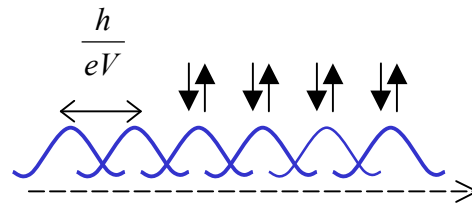

electrons can be viewed as a noiseless incoming stream of spin-singlet pairs.

a weakly transparent barrier lead to generation of entangled electron-hole pairs

the rate of entanglement production is: $D \frac{eV}{h}$

$= 2 \text{ GHz}$
 $V=100\mu\text{V}$
 $D=0.1$

Intel® : beware !

$$|\psi\rangle_{in} = a_{\uparrow}^{\dagger} a_{\downarrow}^{\dagger} |0\rangle$$

$$|\psi\rangle_{out} = (\sqrt{1-D} b_{\uparrow L}^{\dagger} + \sqrt{D} b_{\uparrow R}^{\dagger})(\sqrt{1-D} b_{\downarrow L}^{\dagger} + \sqrt{D} b_{\downarrow R}^{\dagger}) |0\rangle_{out}$$

$$\approx \left[(1-D) b_{\uparrow L}^{\dagger} b_{\downarrow L}^{\dagger} + \sqrt{2D(1-D)} \frac{1}{\sqrt{2}} (b_{\uparrow L}^{\dagger} b_{\downarrow R}^{\dagger} + b_{\uparrow R}^{\dagger} b_{\downarrow L}^{\dagger}) + O(D) \right] |0\rangle_{out}$$

redefinition of the left Fermi sea (for outgoing states) :

$$|\tilde{0}\rangle_{out} = b_{\uparrow L}^{\dagger} b_{\uparrow L}^{\dagger} |0\rangle_{out}$$

$$|\psi\rangle_{out} = |\tilde{0}\rangle_{out} + \sqrt{2D(1-D)} \frac{1}{\sqrt{2}} (b_{\downarrow L} b_{\downarrow R}^{\dagger} + b_{\uparrow R}^{\dagger} b_{\uparrow L}) |\tilde{0}\rangle_{out}$$

hole operators : $h_{\uparrow L}^{\dagger} = b_{\uparrow L}$ $h_{\downarrow L}^{\dagger} = -b_{\downarrow L}$

$$|\psi\rangle_{out} = |\tilde{0}\rangle_{out} + \sqrt{2D(1-D)} \frac{1}{\sqrt{2}} (b_{\downarrow R}^{\dagger} h_{\downarrow L}^{\dagger} + b_{\uparrow R}^{\dagger} h_{\uparrow L}^{\dagger}) |\tilde{0}\rangle_{out}$$

entangled electron-hole pairs

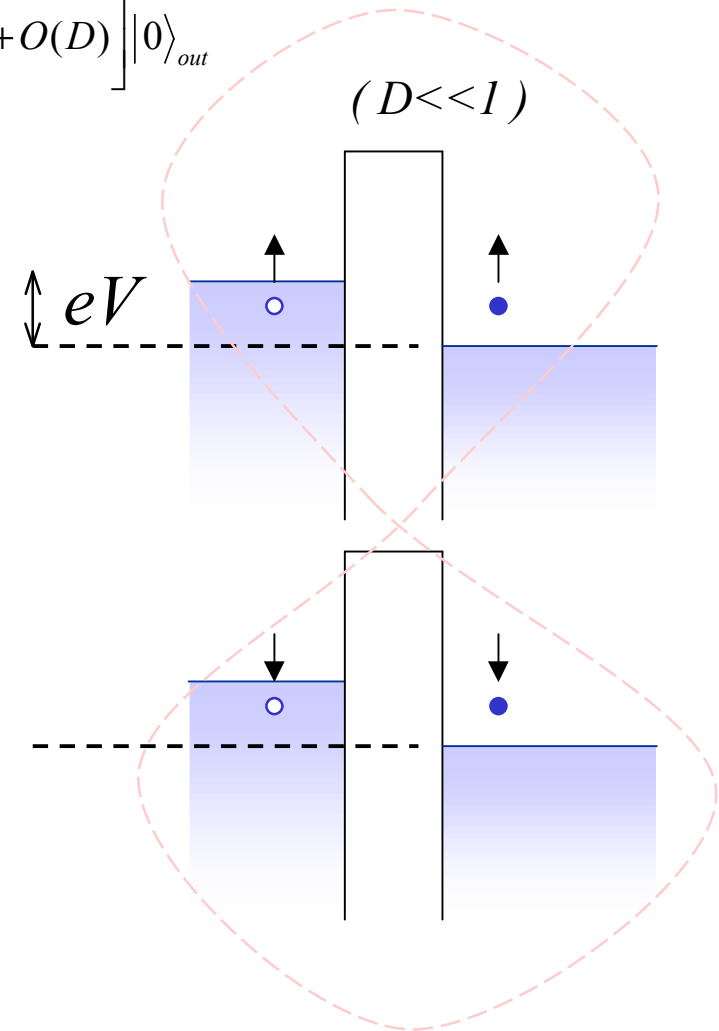

detecting spin correlations in conductors is difficult
spin filters are not yet well mastered.

other approaches can use pseudo spins:

(C. W. J. Beenakker, C. Emary, M. Kindermann, and J.L. van Velsen, Phys. Rev. Lett. 91, 147901 (2003).
P. Samuelsson, E. V. Sukhorukov, and M. Büttiker, Phys. Rev. Lett. 91, 157002 (2003).
P. Samuelsson, E. V. Sukhorukov, and M. Büttiker Phys. Rev. Lett. 92, 026805 (2004).)

thanks to the **noiseless** properties of the Fermi sea :

two thermodynamically independent contacts

combined with electronic **beams splitters**

and **coincidence** measurements

is sufficient to **entangle** electrons

without the need of interactions

two-particle interference (prior to entangled states)

(P. Samuelsson, E.V. Sukhorukov, M. Buttiker)
Phys. Rev. Lett. 92, 026805 (2004)

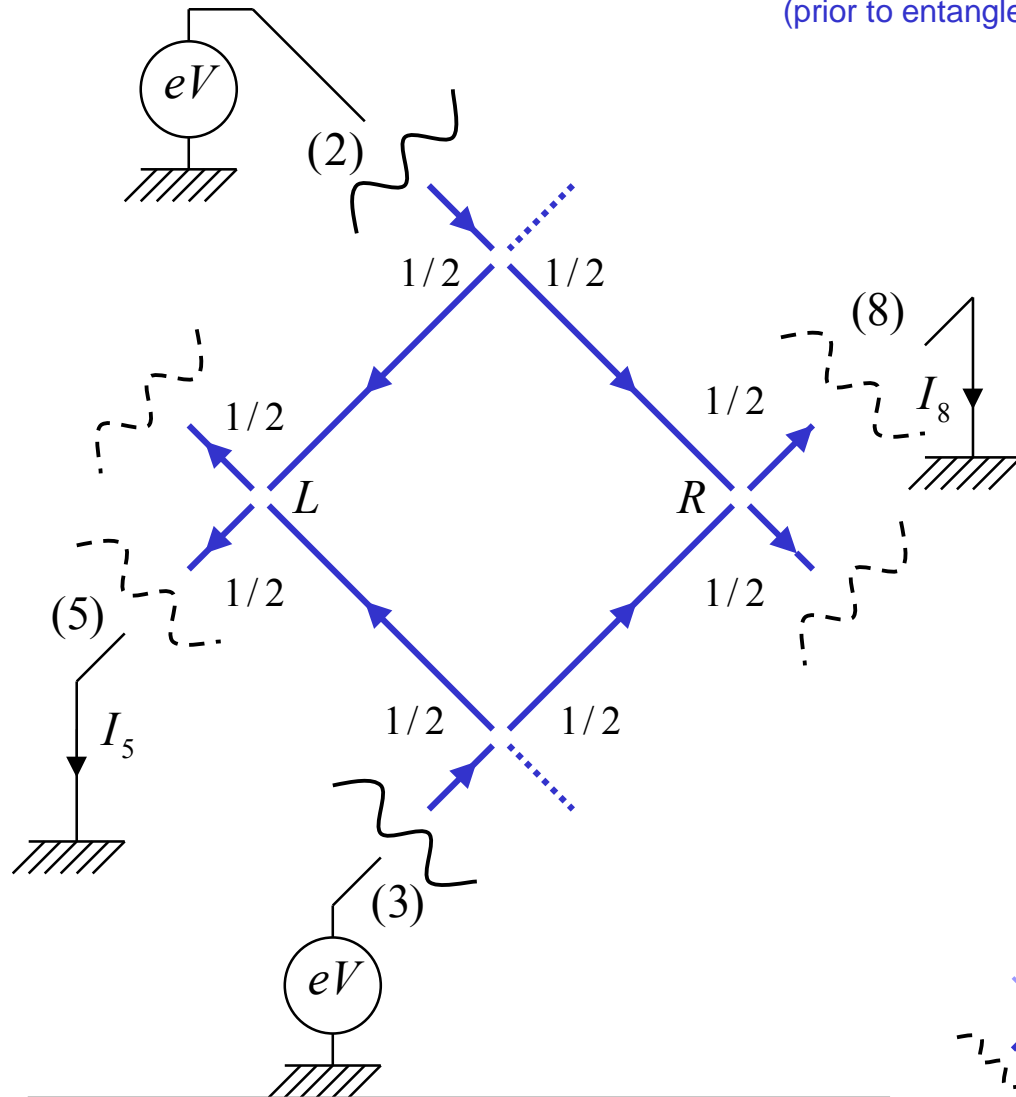

electrons are injected from (2) and (8)
at frequency eV/h and detected in a
coincidence measurement in (5) and (8)

the two-particle probability to reach
simultaneously 5 and 8 is:

$$P_2 = \frac{1}{4^2} \left| e^{i\Phi_A} e^{i\Phi_B} + e^{i\Phi_C} e^{i\Phi_D} \right|^2$$

$$= \frac{1}{8} (1 + \cos(\Phi_A + \Phi_B - \Phi_C - \Phi_D))$$

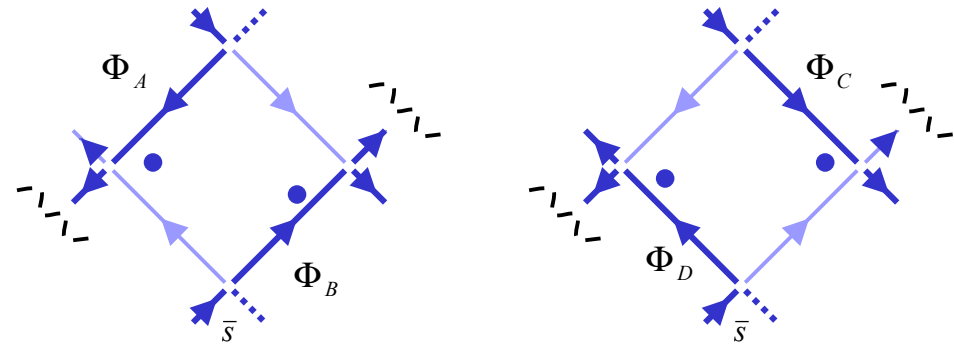

(note: the arbitrary phase associated with the emission of each particle by the reservoirs is the same for the two paths and thus does not spoiled the two-particle interference effect. Only the *relative* phase between particle matters. The only condition is that particle wavefunctions largely overlap when they meet at (L) or (R).

no single particle interference

one can add an AB flux through the loop: $\Phi_A + \Phi_B - \Phi_C - \Phi_D + 2\pi \frac{\Phi_{AB}}{\Phi_0}$

two-particle interference

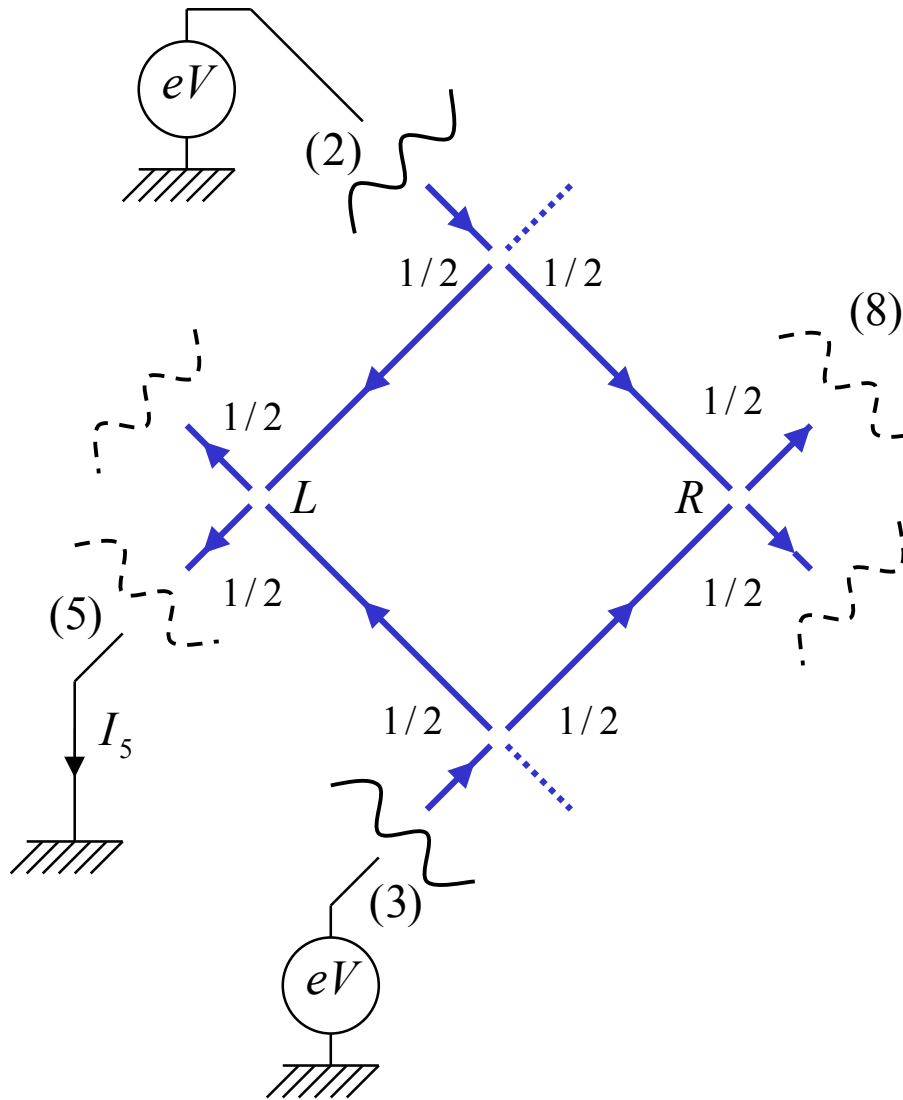

the two-particle interference are expected observable via **current shot noise correlations**:

$$S_{\alpha\beta} = -2 \frac{e^2}{h} \int d\varepsilon \left(\sum_{\gamma} s_{\alpha\gamma}^* s_{\beta\gamma} (f_{\gamma} - f_{\alpha}) \right) \left(\sum_{\delta} s_{\alpha\delta} s_{\beta\delta}^* (f_{\delta} - f_{\alpha}) \right)$$

$$S_{58} = -2 \frac{e^2}{h} eV \left| s_{52}^* s_{82} + s_{53}^* s_{83} \right|^2 \quad \begin{array}{l} \text{(exchange terms)} \\ \text{(not transmission products!)} \end{array}$$

$$S_{58} = -2 \frac{e^2}{h} \frac{eV}{2} \left(1 + \cos \left(\Phi_A + \Phi_B - \Phi_C - \Phi_D + 2\pi \frac{\Phi_{AB}}{\Phi_0} \right) \right)$$

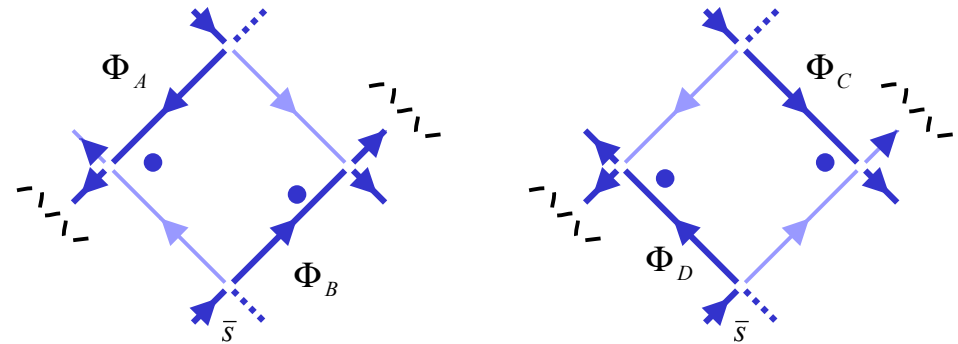

- the two-particle quantum correlation indicates entangled state
- current correlations select the events where the particles jointly appear at (L) and (R).

entangling Fermions emitted by thermodynamically different reservoirs

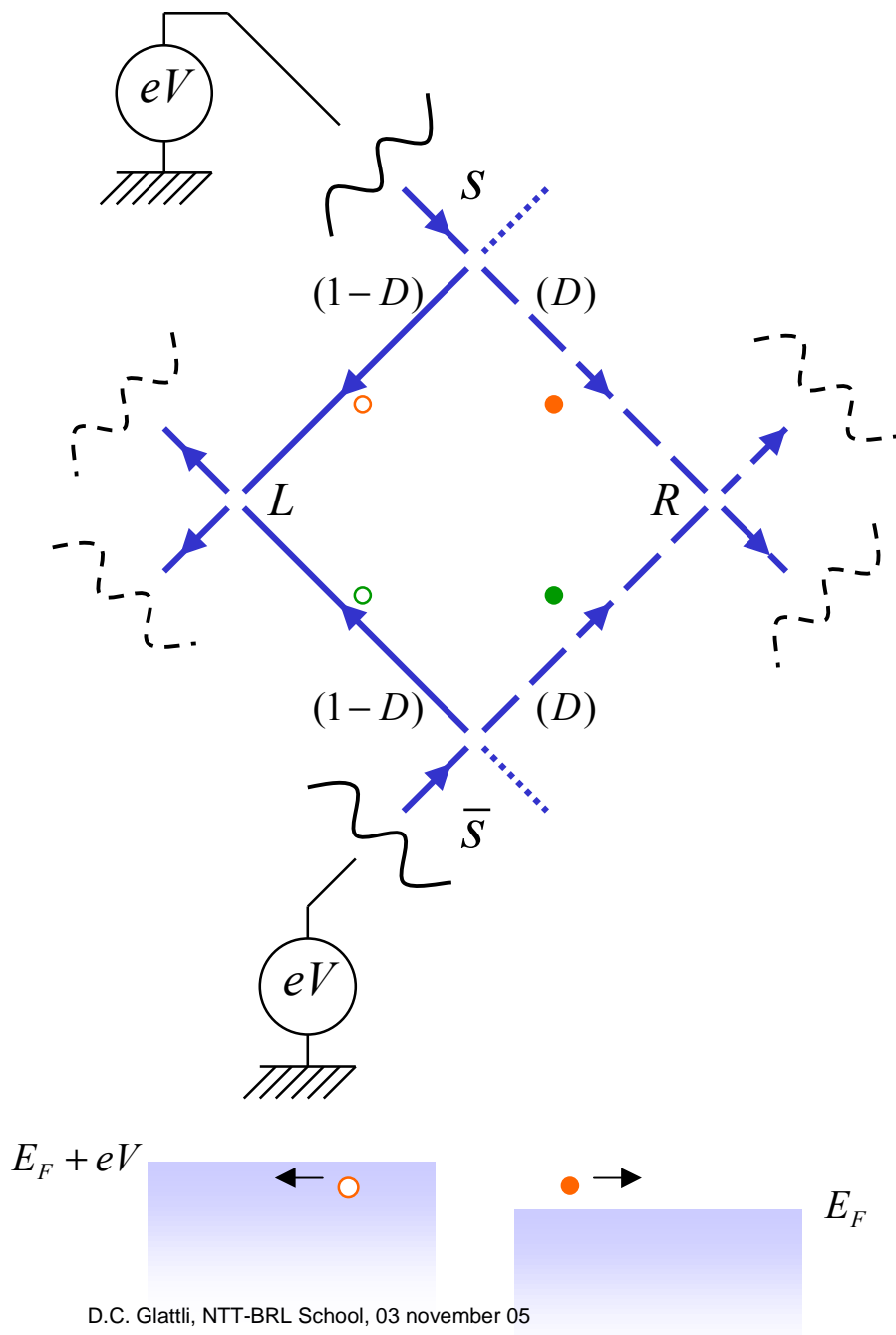

- reservoirs regularly inject electrons at frequency eV/h

$s \leftrightarrow \uparrow$
 $\bar{s} \leftrightarrow \downarrow$ (pseudo-spin representation)

$$|\psi\rangle_{in} = c_{\uparrow}^+ c_{\downarrow}^+ |0\rangle \left(\equiv \prod_{0 < \epsilon \leq eV} c_{\uparrow}^+(\epsilon) c_{\downarrow}^+(\epsilon) |0\rangle \right)$$

$$|\psi\rangle_{out} = (\sqrt{1-D} c_{\uparrow,L}^+ + \sqrt{D} c_{\uparrow,R}^+) (\sqrt{1-D} c_{\downarrow,L}^+ + \sqrt{D} c_{\downarrow,R}^+) |0\rangle$$

$$= \left[(1-D) c_{\uparrow,L}^+ c_{\downarrow,L}^+ + D c_{\uparrow,R}^+ c_{\downarrow,R}^+ + \dots \right. \\ \left. \dots \sqrt{D(1-D)} (c_{\uparrow,L}^+ c_{\downarrow,R}^+ + c_{\uparrow,R}^+ c_{\downarrow,L}^+) \right] |0\rangle$$

for $D \ll 1$, left states are filled up to eV

$$|\tilde{0}\rangle = c_{\uparrow,L}^+ c_{\downarrow,L}^+ |0\rangle \quad (\text{new vacuum})$$

$$|\psi\rangle_{out} \approx |\tilde{0}\rangle + \sqrt{D} (c_{\downarrow,R}^+ c_{\downarrow,L}^+ + c_{\uparrow,R}^+ c_{\uparrow,L}^+) |\tilde{0}\rangle + \mathcal{O}(D^2)$$

$$|\psi\rangle_{out} = |\tilde{0}\rangle_{out} + \sqrt{D} (b_{\downarrow,R}^+ h_{\downarrow,L}^+ + b_{\uparrow,R}^+ h_{\uparrow,L}^+) |\tilde{0}\rangle_{out}$$

entangled electron-hole pairs

analyzing the outputs

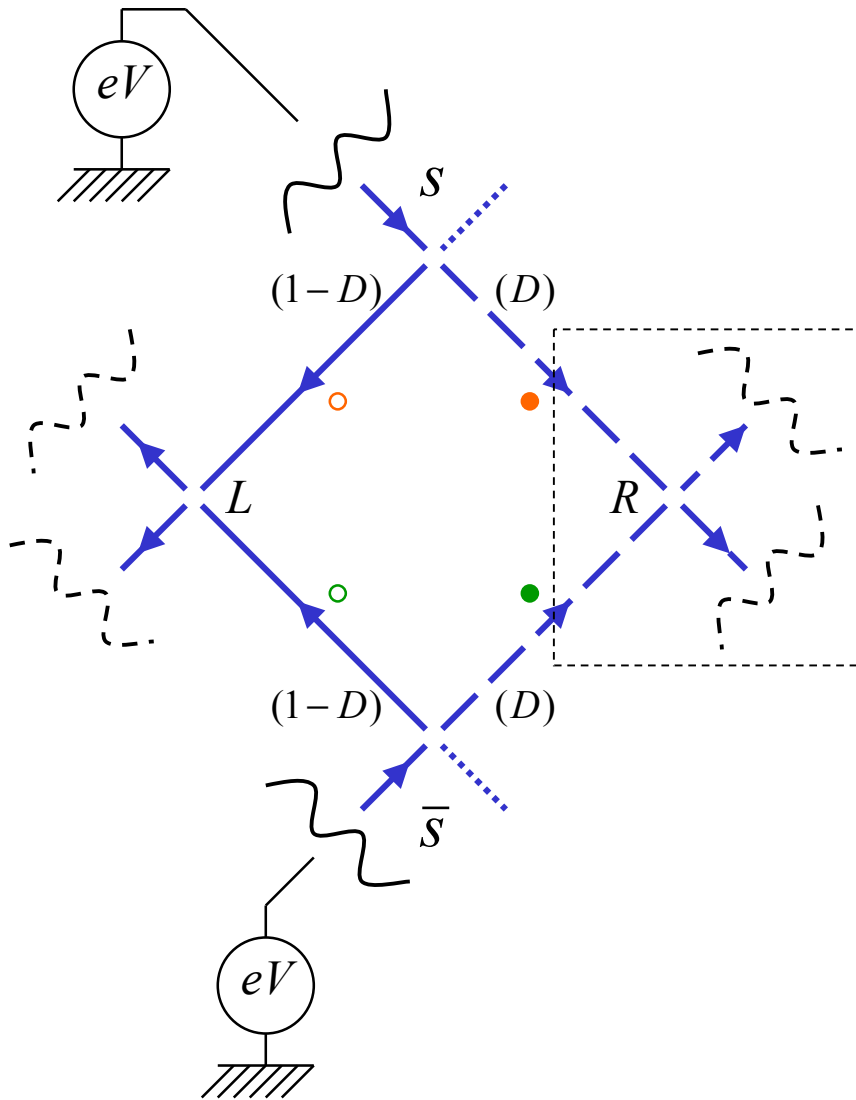

$s \leftrightarrow \uparrow$ (pseudo-spin representation)

$\bar{s} \leftrightarrow \downarrow$

$$S_R = \begin{pmatrix} \cos \frac{\theta_R}{2} & \sin \frac{\theta_R}{2} \\ -\sin \frac{\theta_R}{2} & \cos \frac{\theta_R}{2} \end{pmatrix}$$

$$D_R = \sin^2 \frac{\theta_R}{2}$$

$$1 - D_R = \cos^2 \frac{\theta_R}{2}$$

$$\theta_R = 0$$

↑

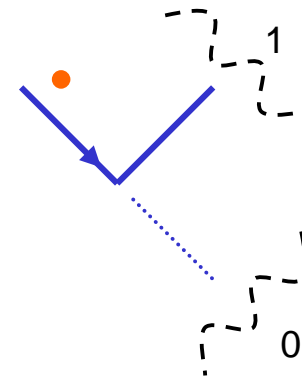

$$\theta_R = \pi$$

↓

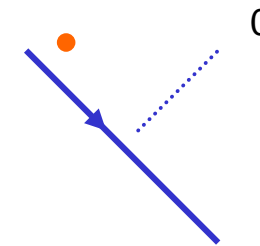

1

analyzing the outputs

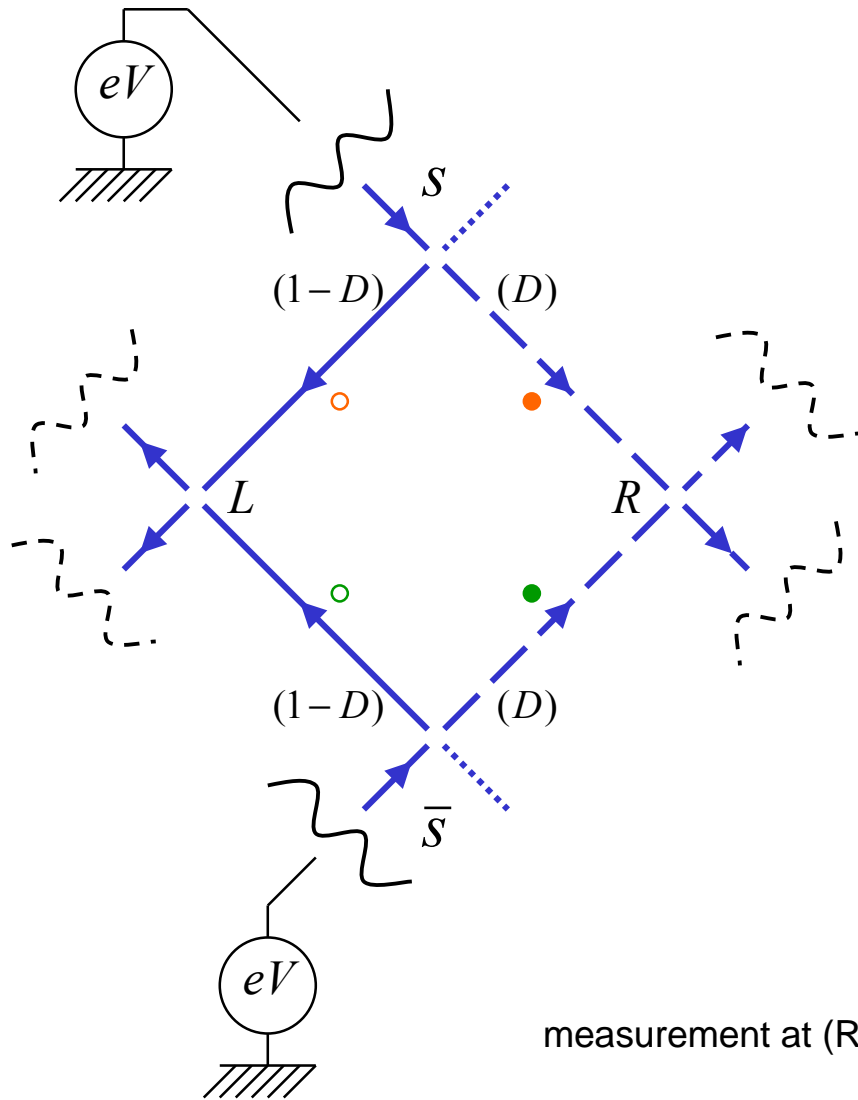

$s \leftrightarrow \uparrow$
 $\bar{s} \leftrightarrow \downarrow$
 (pseudo-spin representation)

$$D_R = \sin^2 \frac{\theta_R}{2}$$

$$1 - D_R = \cos^2 \frac{\theta_R}{2}$$

$$\theta_R = \frac{\pi}{2}$$

$$\rightarrow$$

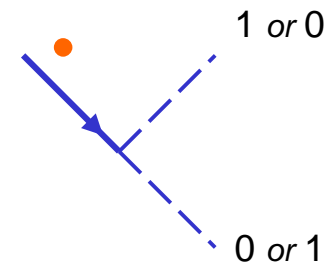

$$|\psi\rangle_{out} \approx |\tilde{0}\rangle + \sqrt{D} (c_{\downarrow,R}^+ c_{\downarrow,L} + c_{\uparrow,R}^+ c_{\uparrow,L}) |\tilde{0}\rangle + \mathcal{O}(D^2)$$

measurement at (R) :

$$\frac{1}{\sqrt{2}} (c_{\downarrow,R}^+ + c_{\uparrow,R}^+) (c_{\downarrow,R}^+ c_{\downarrow,L} + c_{\uparrow,R}^+ c_{\uparrow,L}) |\tilde{0}\rangle$$

project the state at (L) :

$$\Rightarrow \frac{1}{\sqrt{2}} (c_{\downarrow,L} + c_{\uparrow,L}) |\tilde{0}\rangle$$

entanglement results from the fact that we no longer know from which source comes the electron-hole pair

the joint probability to arrive in detectors (contacts) L(R), $\uparrow(\downarrow)$ is obtained from:

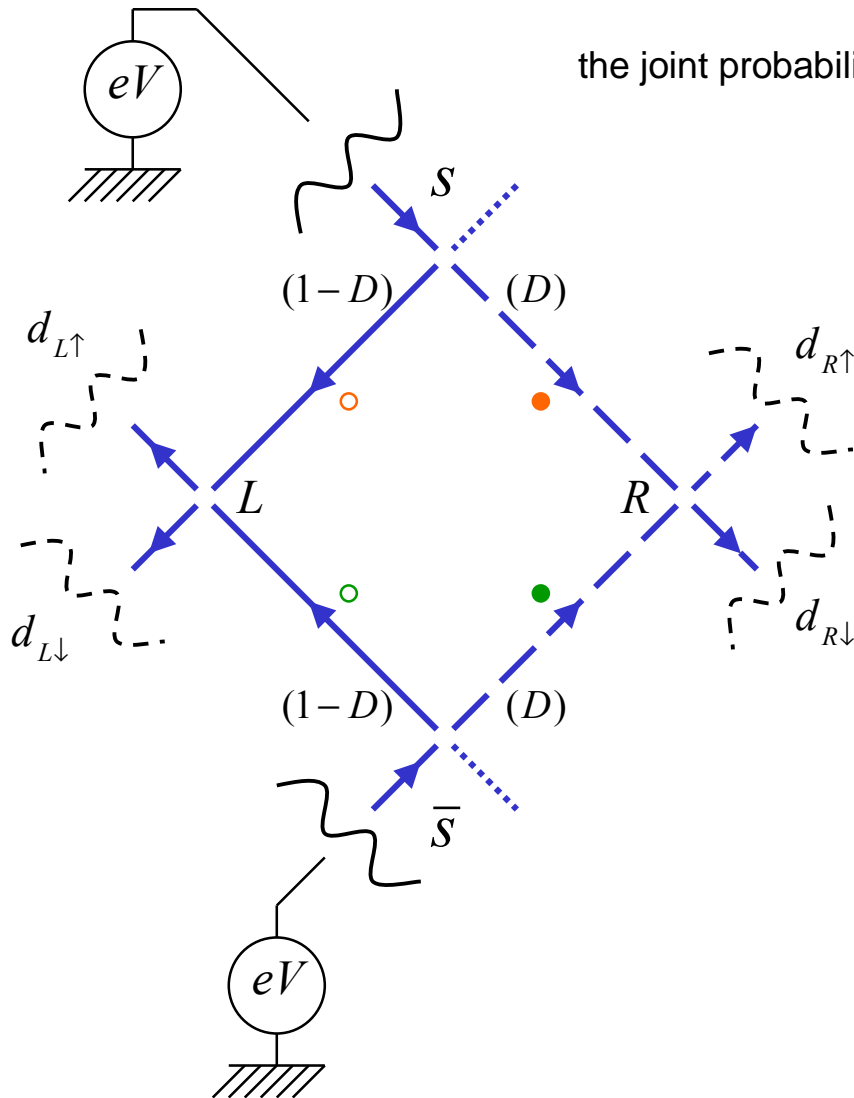

$$S_L = \begin{pmatrix} \cos \frac{\theta_L}{2} & \sin \frac{\theta_L}{2} \\ -\sin \frac{\theta_L}{2} & \cos \frac{\theta_L}{2} \end{pmatrix} \quad \begin{pmatrix} d_{\uparrow L} \\ d_{\downarrow L} \end{pmatrix} = S_L \begin{pmatrix} h_{\uparrow L} \\ h_{\downarrow L} \end{pmatrix}$$

$$S_R = \begin{pmatrix} \cos \frac{\theta_R}{2} & \sin \frac{\theta_R}{2} \\ -\sin \frac{\theta_R}{2} & \cos \frac{\theta_R}{2} \end{pmatrix} \quad \begin{pmatrix} d_{\uparrow R} \\ d_{\downarrow R} \end{pmatrix} = S_R \begin{pmatrix} c_{\uparrow R} \\ c_{\downarrow R} \end{pmatrix}$$

$$P_{L\uparrow,R\uparrow} = P_{L\downarrow,R\downarrow} = D \cos^2 \left(\frac{\theta_L - \theta_R}{2} \right)$$

$$P_{L\uparrow,R\downarrow} = P_{L\downarrow,R\uparrow} = D \sin^2 \left(\frac{\theta_L - \theta_R}{2} \right)$$

(for zero A-B flux through the loop)

While the case $\theta_L = \theta_R = 0$ (or π) is trivial and classically expected, other cases like $\theta_L = \theta_R = \pi/2$ is not classically expected and results from quantum interferences between two possible indistinguishable electron-hole pairs.

The system bears strong similarity with (1982) Aspect's photon experiment but here the Fermi statistics allows to use simple sources.

difference between electron and photons and thermal effect:

thermodynamic sources of photons:

bosonic statistics and the fluctuations of the source prevent entanglement

using purely *linear optics* (W. Xiang-bin, Phys. Rev. A 66, 024303 (2002))

What about thermal fluctuations for Fermions?

rate of entanglement production at zero temperature:

$$\dot{E} = \frac{eV}{h} D \quad D \ll 1$$

the rate decreases and vanishes abruptly at a critical temperature (C. Beenakker 2005):

$$D(1-D) \sinh^2 \left(\frac{eV}{2k_B T_c} \right) = \frac{1}{4}$$

$$T_c = \frac{eV}{k_B \ln(1/D)} \quad D \ll 1$$

C.W.J. Beenakker, cond-mat/0508488

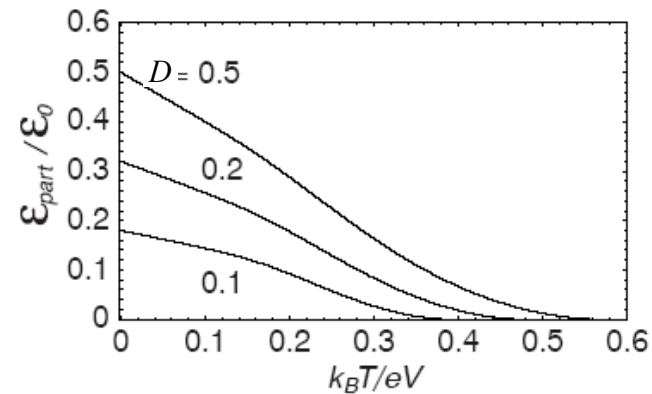

entanglement production in units eV/h for various values of the transmission D

from : C.W.J. Beenakker, cond-mat/0508488

Introduction

I. Electronic scattering (a brief introduction)

II. Quantum Shot noise

III Shot Noise and Interactions:

IV. Shot noise: *the* tool to detect entanglement

1. Entanglement with the Fermi statistics

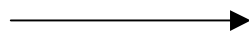

2. Coincidence measurements using shot noise correlations

V. Shot noise and high frequencies

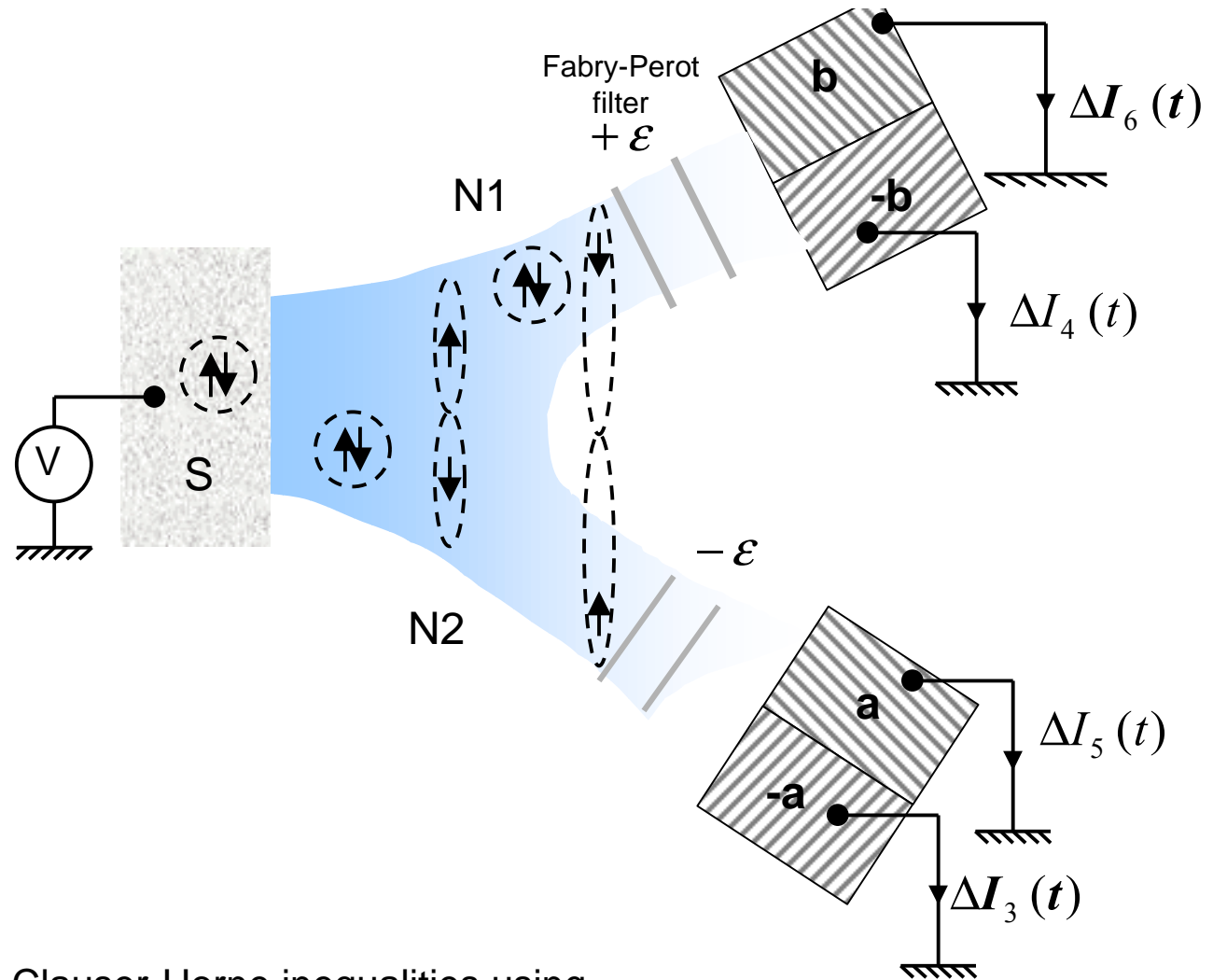

Possibility to test Bell ou Clauser-Horne inequalities using the [current-current correlations](#) (Chtchelkatchev, Blatter, Lesovik and Martin et al 2002)

$$\mathcal{S}_{56}(a, b) - \mathcal{S}_{56}(a, b') + \mathcal{S}_{56}(a', b) + \mathcal{S}_{56}(a', b') - \mathcal{S}_{56}(a', -) - \mathcal{S}_{56}(-, b) \leq 0$$

$\mathcal{S}_{56}(a', -)$ noise when
no filter in the upper arm

maximally violated for

$$\theta_{a,b} = \vartheta_{a',b'} = \frac{\pi}{2}$$

$$\theta_{a,b'} = \frac{\pi}{4} \quad \text{and} \quad \theta_{a',b} = \frac{3\pi}{4}$$

IV. 2. current shot noise cross-correlations to test entanglement

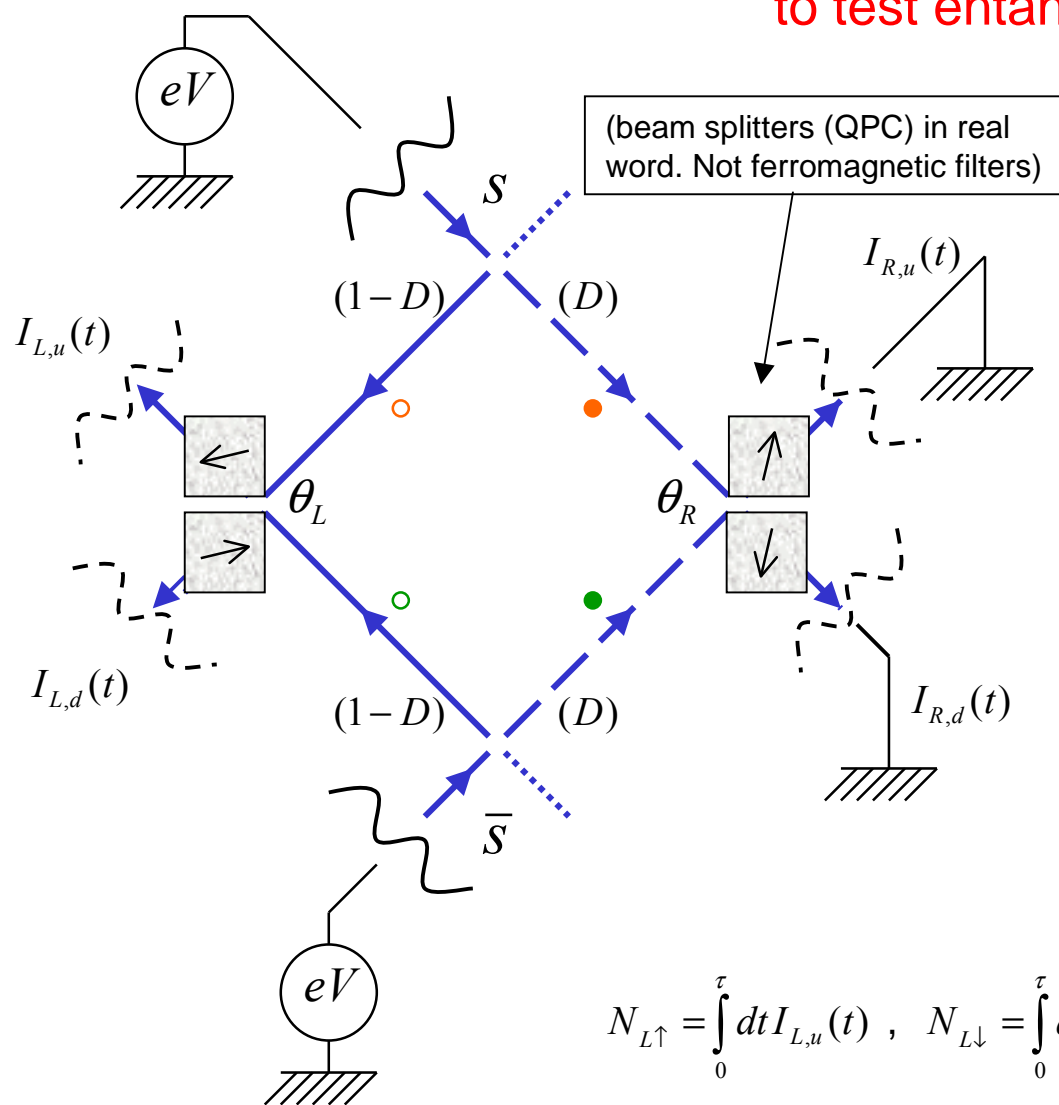

$s \leftrightarrow \uparrow$ (pseudo-spin representation)
 $\bar{s} \leftrightarrow \downarrow$

$$\begin{aligned}
 C_{\vec{a}\vec{b}} &= \langle (\vec{a} \cdot \vec{\sigma})_L \otimes (\vec{b} \cdot \vec{\sigma})_R \rangle \\
 &= \frac{\langle (N_{L\uparrow}(\vec{a}) - N_{L\downarrow}(\vec{a})) (N_{R\uparrow}(\vec{b}) - N_{R\downarrow}(\vec{b})) \rangle}{\langle (N_{L\uparrow}(\vec{a}) + N_{L\downarrow}(\vec{a})) (N_{R\uparrow}(\vec{b}) + N_{R\downarrow}(\vec{b})) \rangle}
 \end{aligned}$$

\vec{a} and \vec{b} pseudo - spin polarizer direction

Clouser-Horne-Shimony-Holt form of Bell inequality:

$$B = |C_{\vec{a}\vec{b}} + C_{\vec{a}'\vec{b}} + C_{\vec{a}\vec{b}'} - C_{\vec{a}'\vec{b}'}| \leq 2$$

$$N_{L\uparrow} = \int_0^\tau dt I_{L,u}(t) , \quad N_{L\downarrow} = \int_0^\tau dt I_{L,d}(t) , \quad N_{R\uparrow} = \int_0^\tau dt I_{R,u}(t) , \quad \text{and} \quad N_{R\downarrow} = \int_0^\tau dt I_{R,d}(t)$$

$$\langle N_{Li} N_{Rj} \rangle = S_{Li,Rj}(\omega \approx 0) \tau + \langle I_{Li} \rangle \langle I_{Rj} \rangle \tau^2 \quad i, j = \uparrow, \downarrow$$

current noise correlation

average currents

measurement time

current shot noise cross-correlations to test entanglement

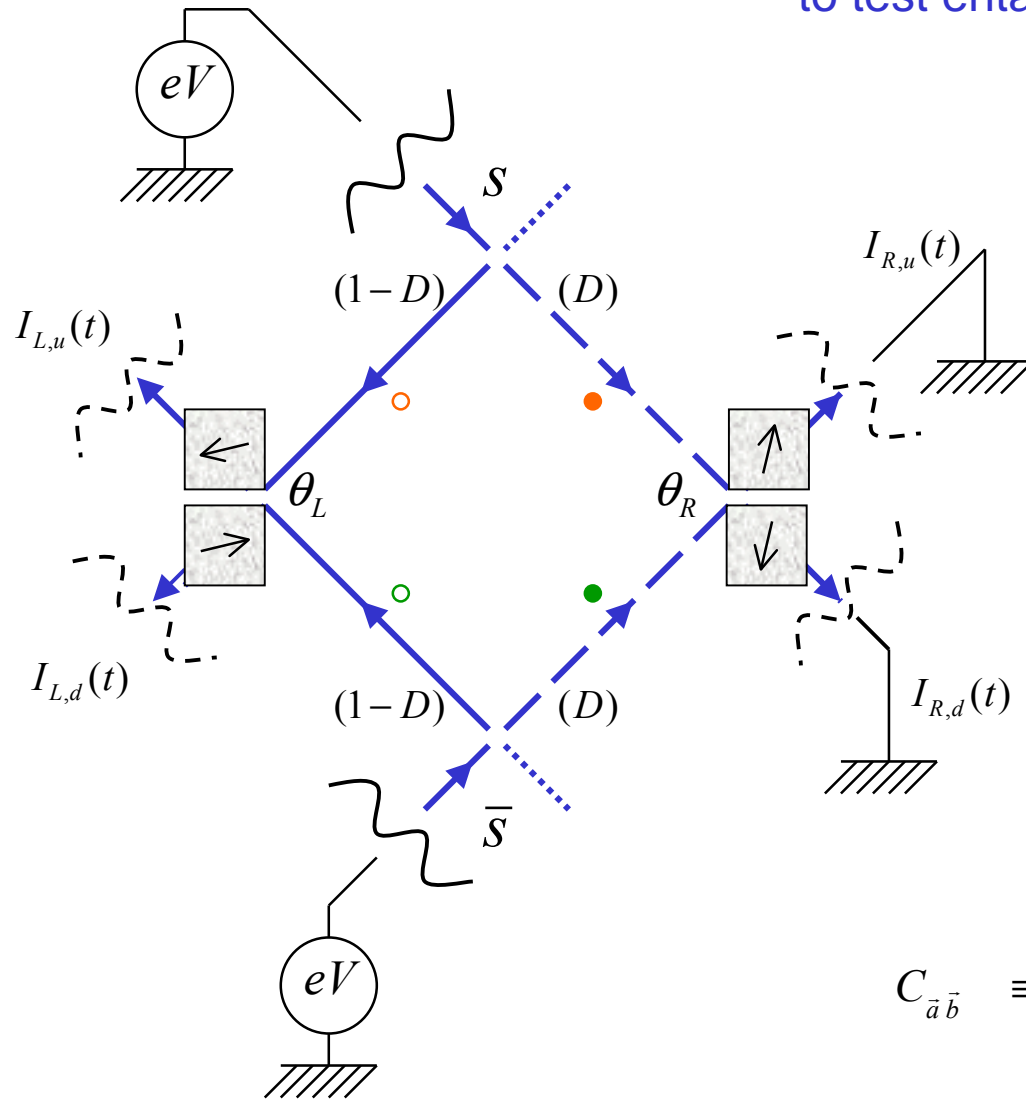

$s \leftrightarrow \uparrow$
 $\bar{s} \leftrightarrow \downarrow$ (pseudo-spin representation)

$$\langle N_{Li} N_{Rj} \rangle = S_{Li,Rj}(\omega \approx 0) \tau + \langle I_{Li} \rangle \langle I_{Rj} \rangle \tau^2 \quad i, j = \uparrow, \downarrow$$

for $\frac{e}{\max(I_{\alpha}^{e(h)})} > \tau \gg \frac{h}{eV}$

$$C_{\bar{a}\bar{b}} \equiv \hat{E}(\theta_R, \theta_L) = \frac{S_{R\downarrow,L\uparrow} + S_{R\uparrow,L\downarrow} - S_{R\downarrow,L\downarrow} - S_{R\uparrow,L\uparrow}}{\sum_{i,j=\uparrow,\downarrow} S_{Ri,Lj}}$$

$$|\tilde{E}(\theta_R, \theta_L) - \tilde{E}(\theta'_R, \theta_L) + \tilde{E}(\theta'_R, \theta'_L) + \tilde{E}(\theta_R, \theta'_L)| \leq 2 \quad \text{can be violated: } 2\sqrt{2}$$

(some) theoretical proposals

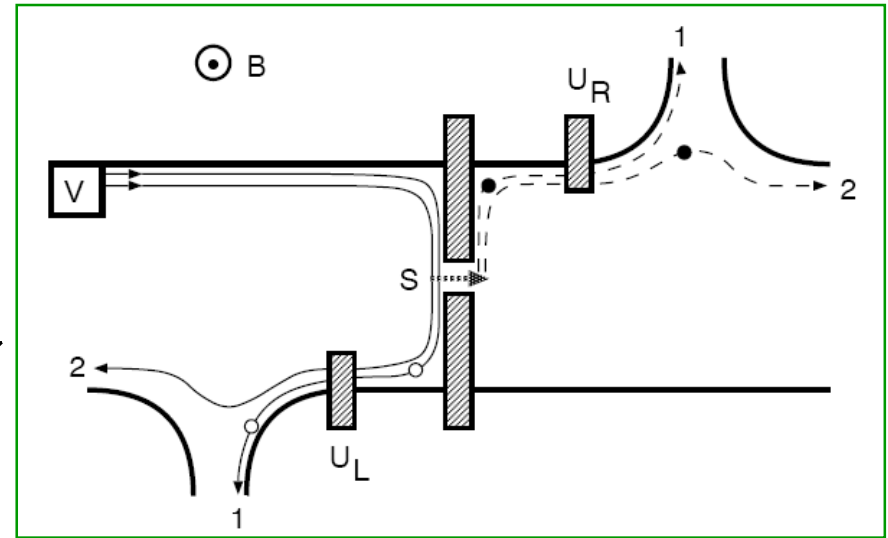
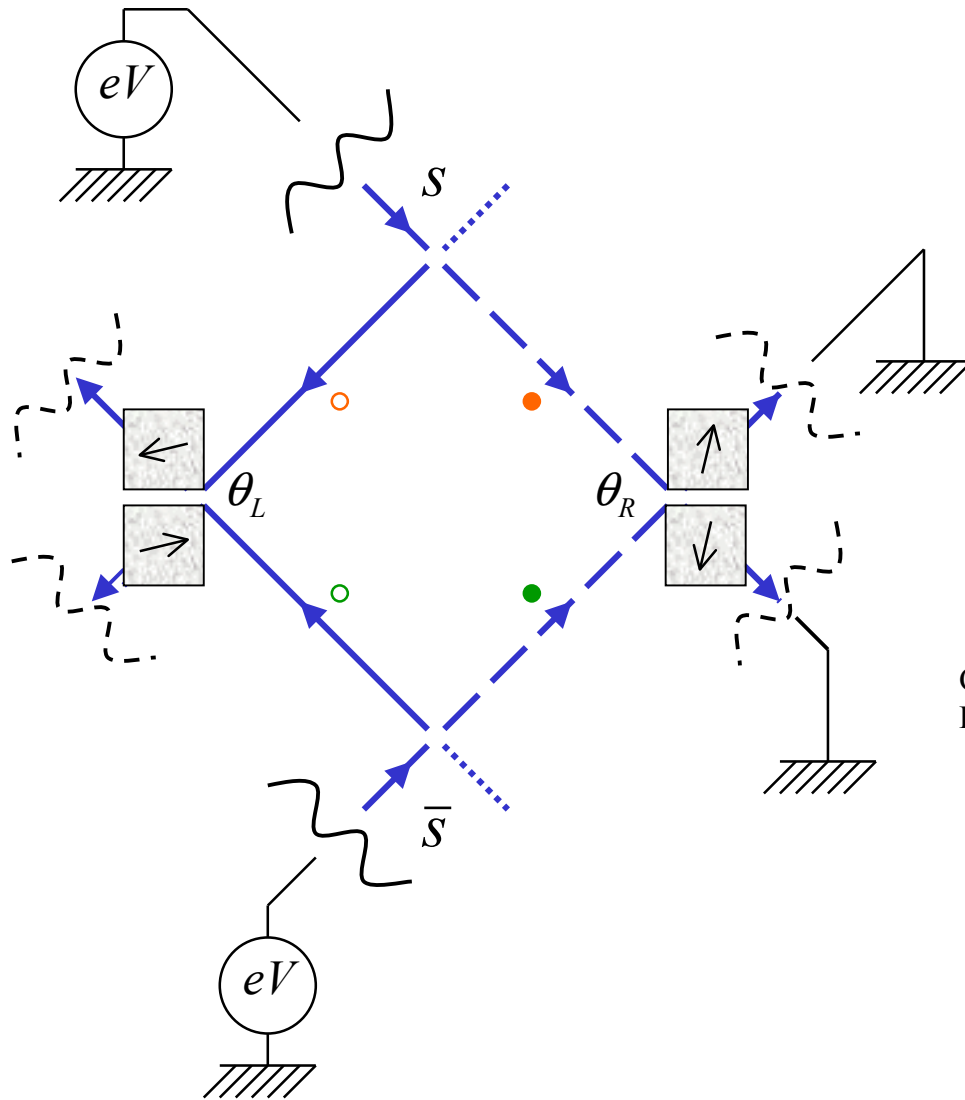

C. W. J. Beenakker, C. Emary, M. Kindermann, and J. L. van Velsen
 Phys.Rev.Lett. 91, 147901 (2003)

(some) theoretical proposals

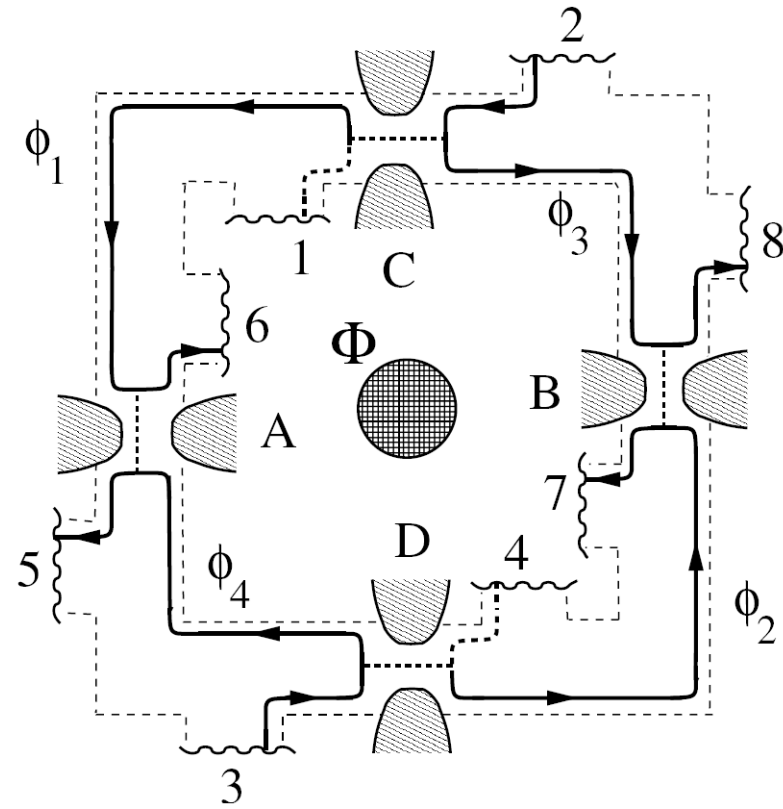
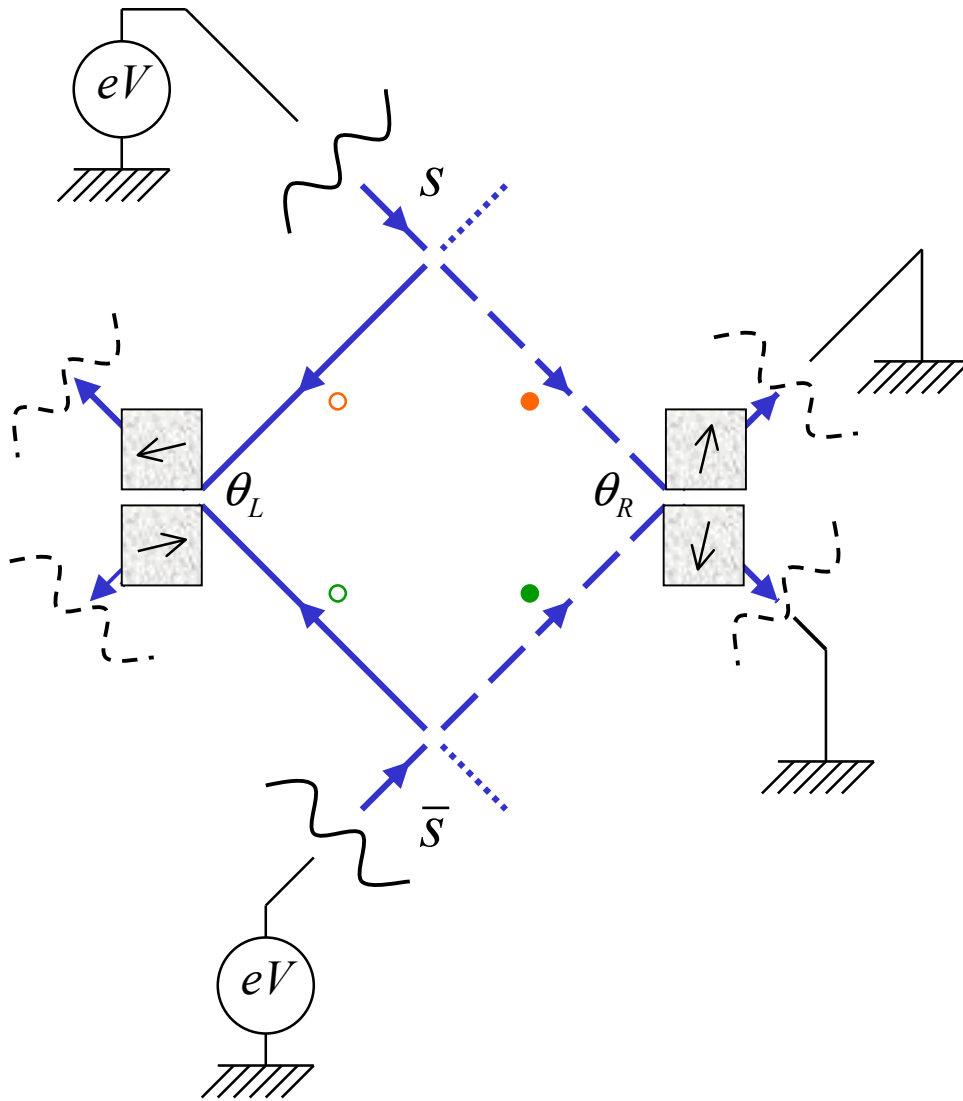

P. Samuelsson, E.V. Sukhorukov, and M. Büttiker
 Phys.Rev.Lett. 92, 026805 (2003)

$$\phi_0 = \phi_1 + \phi_2 - \phi_3 - \phi_4 + 2\pi \frac{\Phi}{h/e}$$

$$2\sqrt{2} \mapsto 2\sqrt{1 + \cos^2(\phi_0)}$$

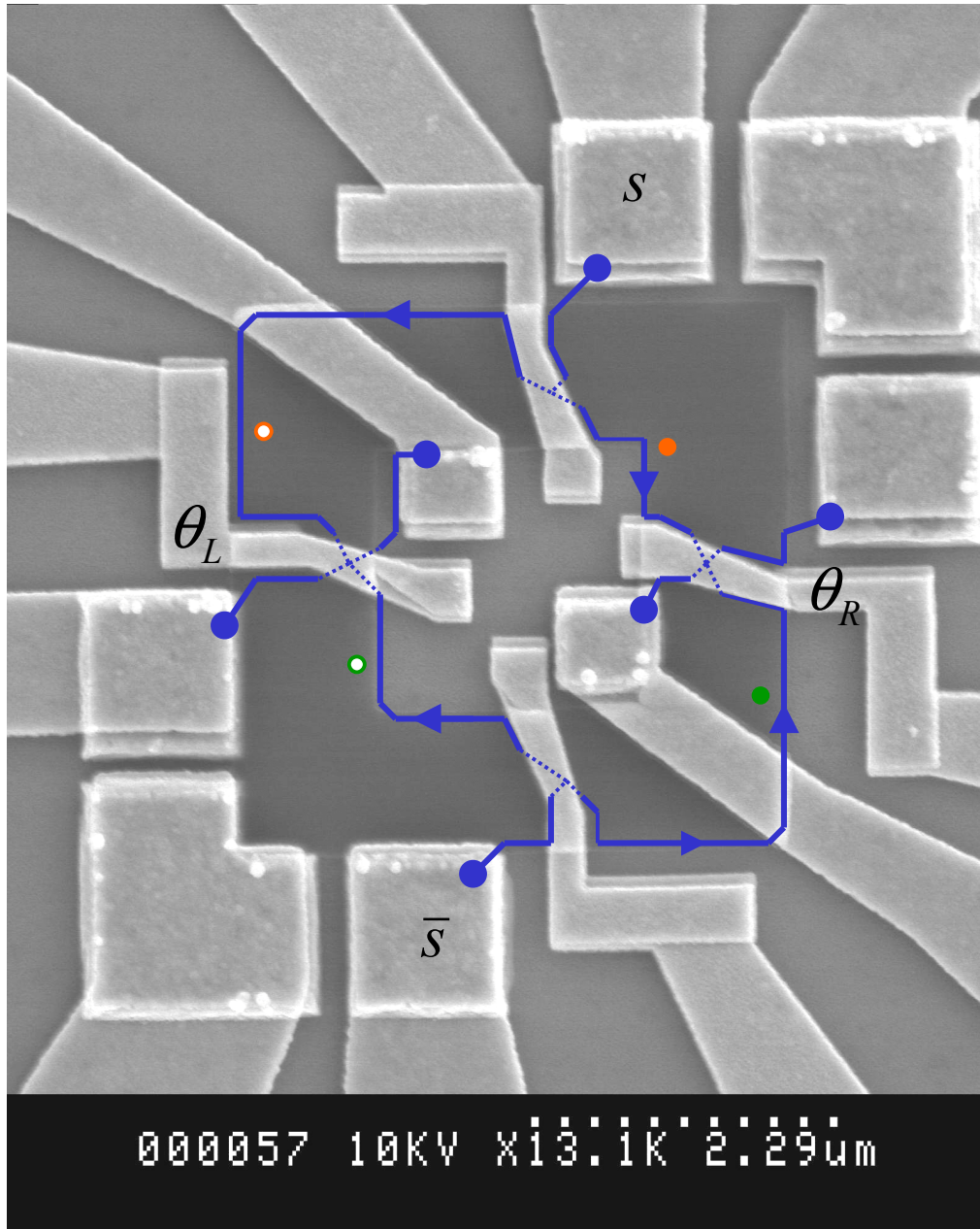

sample realized at LPN Marcoussis
(D. Mailly, G. Faini)

12 μm average perimeter

$\phi_0 = h/e$ for 4.6 Gauss

Orders of magnitude :

$T = 20\text{mK}$

$V = 25 \mu\text{V}$ ($\sim 250\text{mK}$)

$eV/h = 6 \text{ GHz}$

For transmission $D = 0.1$:

$I = 100\text{pA}$ and $\tau^{-1} = I/e \sim 0.6 \text{ GHz}$

$S_1 \sim (6 \text{ fA})^2 / \text{Hz}$ easily measurable in d.c.

... to be measured in Saclay (P. Roche, F. Portier, J. Ségala, P. Roulleau, D.C.G.)

other recent proposal :

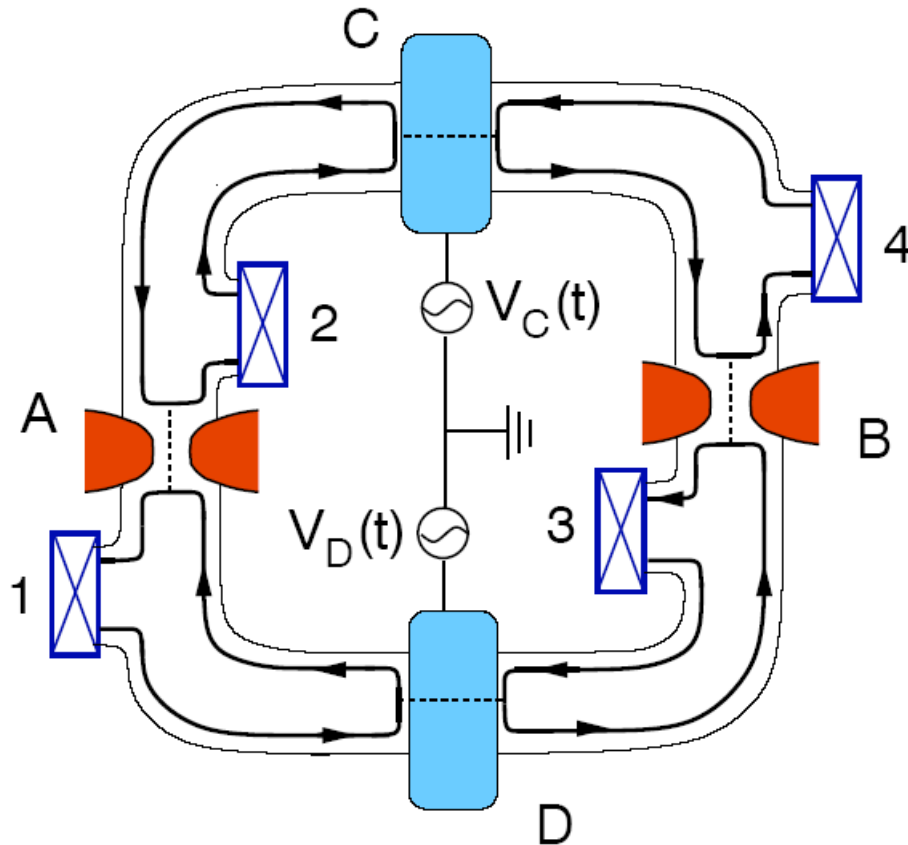

P. Samuelsson and M. Büttiker
cond-mat/0410581 v1 22 Oct 2004

experimentally feasible:

shot noise of photo created **electron-hole** pairs **observed** by us *L.-H. Reydellet et al, Phys.Rev.Lett.90, 176803(2004)*

Avantage : controlled rate, no d.c. bias voltage, less contacts, simpler geometry

Drawback : only 1/2 of photo created hole-pairs are useful, poissonian generation of el.-hole pairs

D.C. Glattli, NTT-BRL School, 03 november 05

a.c. modulation of the transmission: $D \rightarrow D + \delta D(t)$

$$V_{C/D}(t) = V_{C/D} + \delta V_{C/D} \cos(\omega t + \phi_{C/D}).$$

electron-hole pairs are photo-created above the Fermi sea by absorption of a quantum $h\nu$ at a rate :

$$\frac{1}{\tau} \approx \frac{\omega}{2\pi} \delta V_{C,D} \frac{\partial D_{C,D}}{\partial V_{C,D}}$$

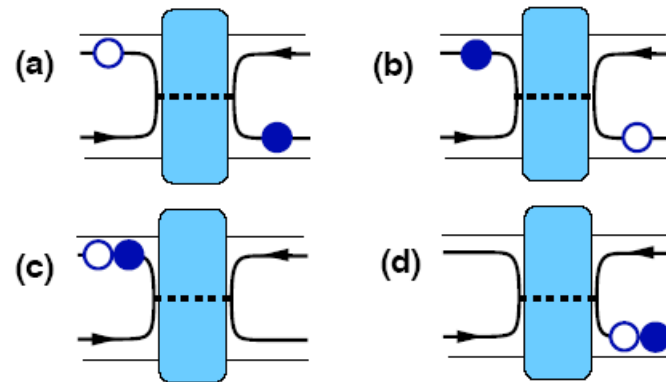
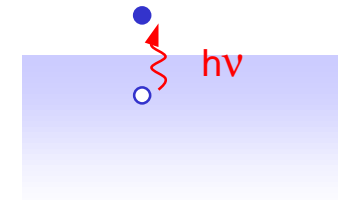

Introduction

I. Electronic scattering (a brief introduction)

II. Quantum Shot noise

III Shot Noise and Interactions:

IV. Shot noise: *the* tool to detect entanglement

V. Shot noise and high frequencies

1. Photo-assisted Shot Noise
2. High frequency Shot Noise
3. Photon Noise emitted by a Conductor

V. 1. photo-assisted shot noise

high frequency magnetic induction electric field
to modulate the electronic phase :

$$\phi(t) = \phi_\omega \cos \omega t$$

photon absorption/emission probability :

$$P_l = J_l^2(\phi_\omega / \phi_0) \quad \phi_0 = h/e \quad \text{“a-c Aharonov-Bohm effect”}$$

$$S_I = \frac{e^2}{h} \left\{ 4k_B T \left(\sum_n D_n^2 \right) + 2 \left(\sum_n D_n (1 - D_n) \right) \left[\sum_{l=1, \infty} J_l^2(\phi_\omega / \phi_0) (l\hbar\omega \pm eV_{dc}) \coth \frac{l\hbar\omega \pm eV_{dc}}{2k_B T} \right] \right\}$$

(! ‘zero’ frequency shot noise)

important prediction (G. B. Lesovik and L. S. Levitov, *Phys. Rev. Lett.* 72 (1994)

and observation (R. J. Schoelkopf, A. A. Kozhevnikov, D. E. Prober, and M. J. Rooks, *Phys. Rev. Lett.* 80 (1998) 2437)

→ made ‘real’ the frequency ‘eV/h’

(measured in a diffusive wire)

(derivative of shot-noise)

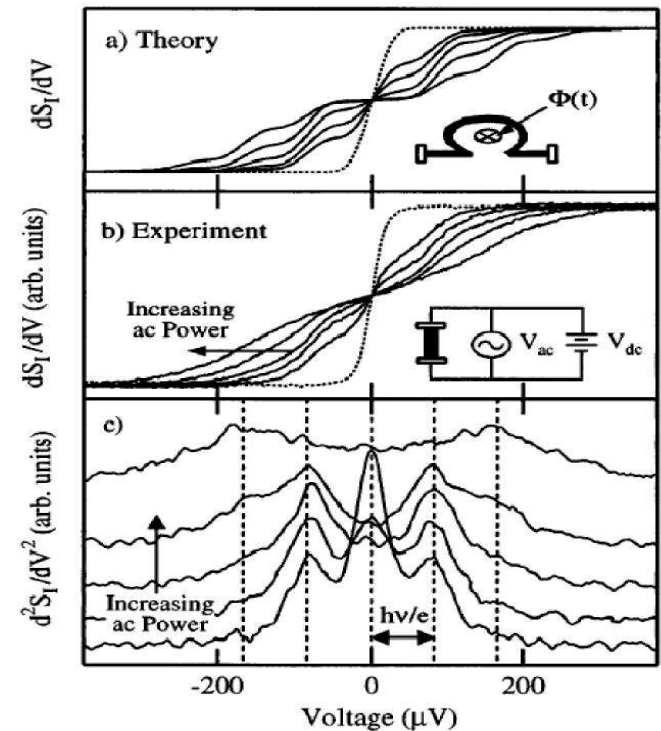
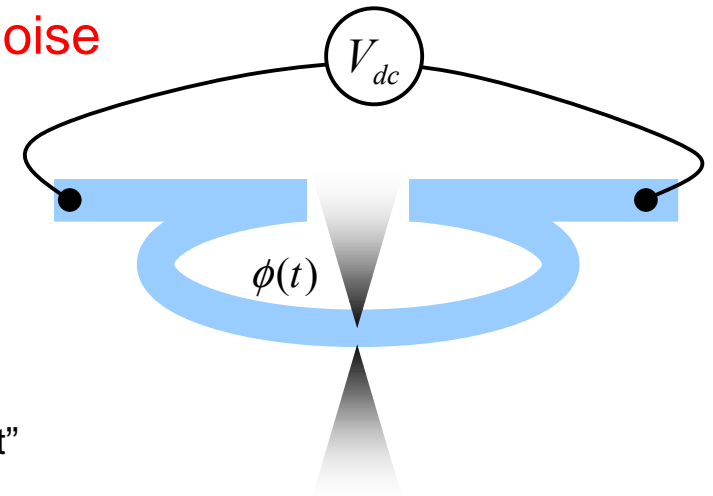

later *Pedersen et al.* (98) : equivalent case of a-c potential

applied to one contact : $V_{a-c}(t) = V_{a-c} \cos \omega t$ with $P_l = J_l^2 (eV_{a-c} / \hbar \omega)$

left reservoir is biased by a **rf voltage**

$$H_L \rightarrow H_L + eV_{a-c} \sin(\omega t)$$

$$e^{ik_L x} \rightarrow e^{ik_L x} e^{i \frac{eV_{a-c} \cos(\omega t)}{\hbar \omega}}$$

$$\hat{a}_L(\epsilon) \rightarrow J_0 \left(\frac{eV_{a-c}}{\hbar \omega} \right) \hat{a}_L(\epsilon) + J_1 \left(\frac{eV_{a-c}}{\hbar \omega} \right) \hat{a}_L(\epsilon \pm \hbar \omega) + \dots$$

note: inverse frequency shorter than the coherent traversal time of electrons in the reservoirs : $\omega > v_F / l_\phi$

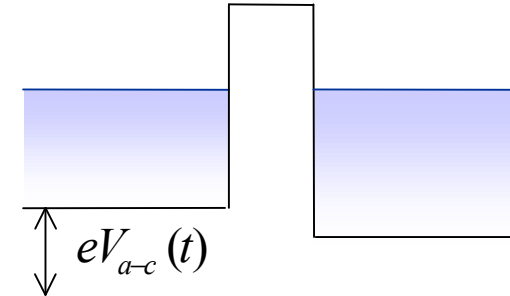

(note: simplified potential representation: due to instantaneous screening by fast plasmons, electric field vary smoothly over λ_F . Details are not expected to give significant changes)

$$S_I = \frac{e^2}{h} \left\{ 4k_B T \left(\sum_n D_n^2 \right) + 2 \left(\sum_n D_n (1 - D_n) \right) \left[\sum_{l=1, \infty} J_l^2 (eV_{a-c} / \hbar \omega) (l\hbar \omega \pm eV_{dc}) \coth \frac{l\hbar \omega \pm eV_{dc}}{2k_B T} \right] \right\}$$

Yale'group have measured derivative of photo-assisted shot noise.

Here, complete (not derivative) shot noise measurement allow to access

the Fano factor (i.e. without d.c. current!)

photo-created electron-hole pairs

an incoming electron is either un-pumped

or pumped above de Fermi sea

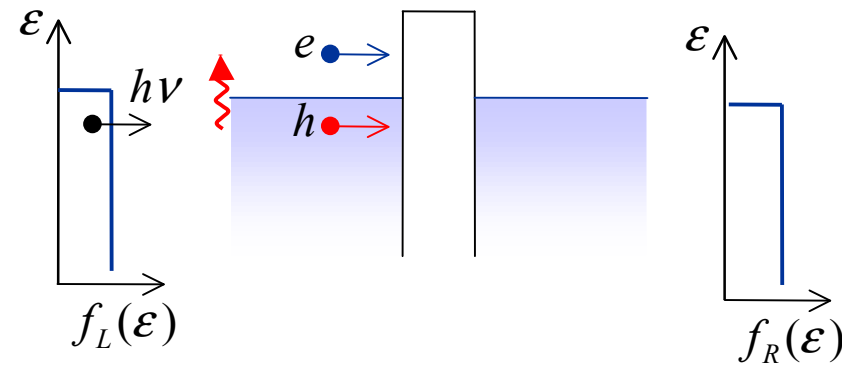
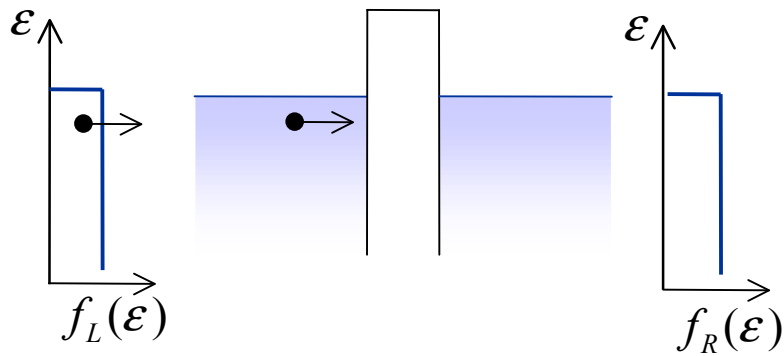

un-pumped electrons do not generate noise (ground state)

pumped electrons do generate noise as e - h pairs are dissociated by the elastic scatter.

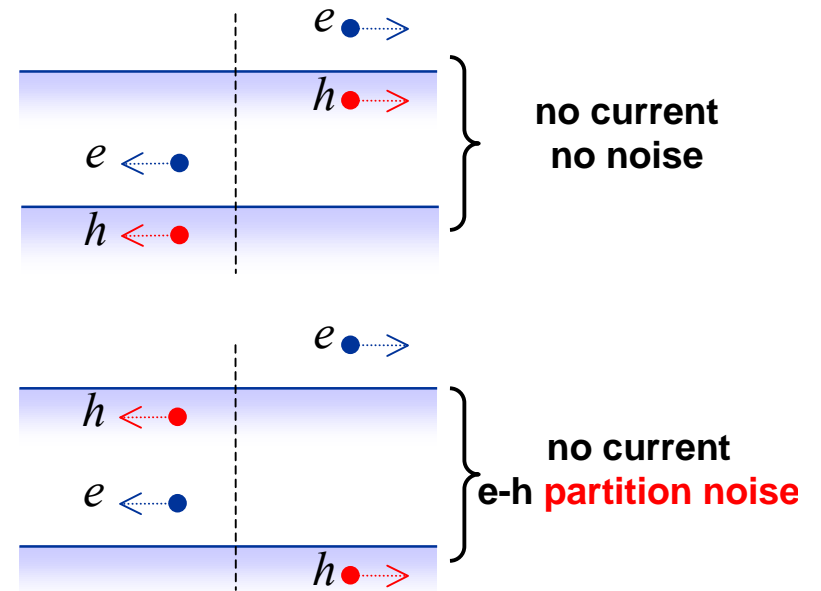

current of pumped incoming **electrons** :

$$I_0^{(e)} = P_1 \frac{e}{h} (h\nu)$$

current of pumped incoming **holes** :

$$I_0^{(h)} = - I_0^{(e)}$$

the two **electron-hole** shot noise contributions give:

$$\begin{aligned} S_I &= 2 e I_0 2_1 D (1-D) \\ &= 4 h\nu \frac{e^2}{h} P_1 D (1-D) \end{aligned}$$

while the mean current : $I = 0$

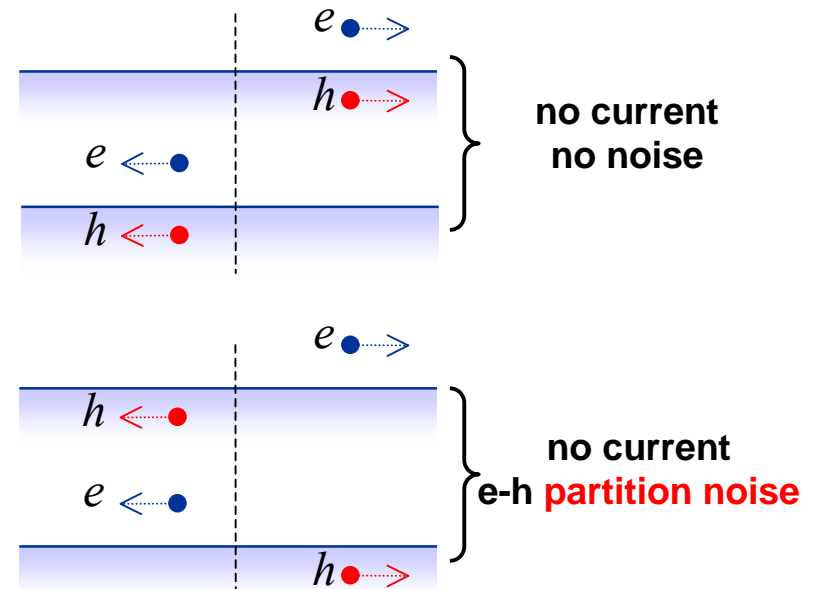
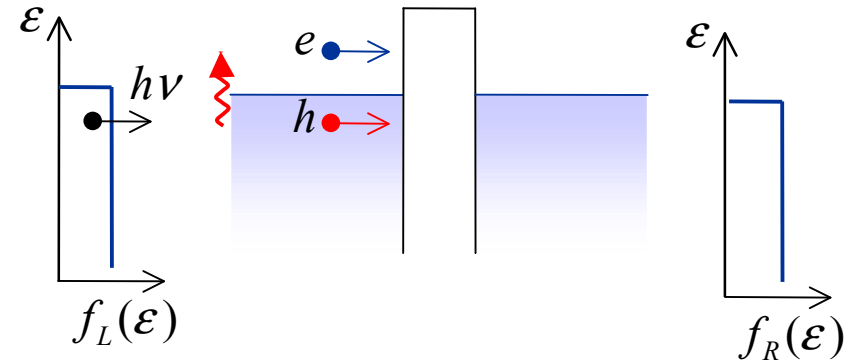

a complete formula :

$$S_I = 4 h\nu \left(\sum_l l P_l \right) \sum_n D_n (1 - D_n) \quad \text{where} \quad P_l = J_l^2 (eV_{a-c} / \hbar \omega)$$

l^{th} –photon absorption n^{th} –electronicmode

$$S_I = 4 G h\nu \left(\sum_l l P_l \right) \frac{\sum_n D_n (1 - D_n)}{\sum_n D_n} \quad \text{FANO factor}$$

Levitov and Lesovik (PRL 94)
Petersen and Buttiker (98)

experimental observation of electron-hole shot noise

- 2 to 4 kHz **cross-correlation** voltage noise measurements.

- calibration checked within 2% accuracy using Johnson-Nyquist noise.

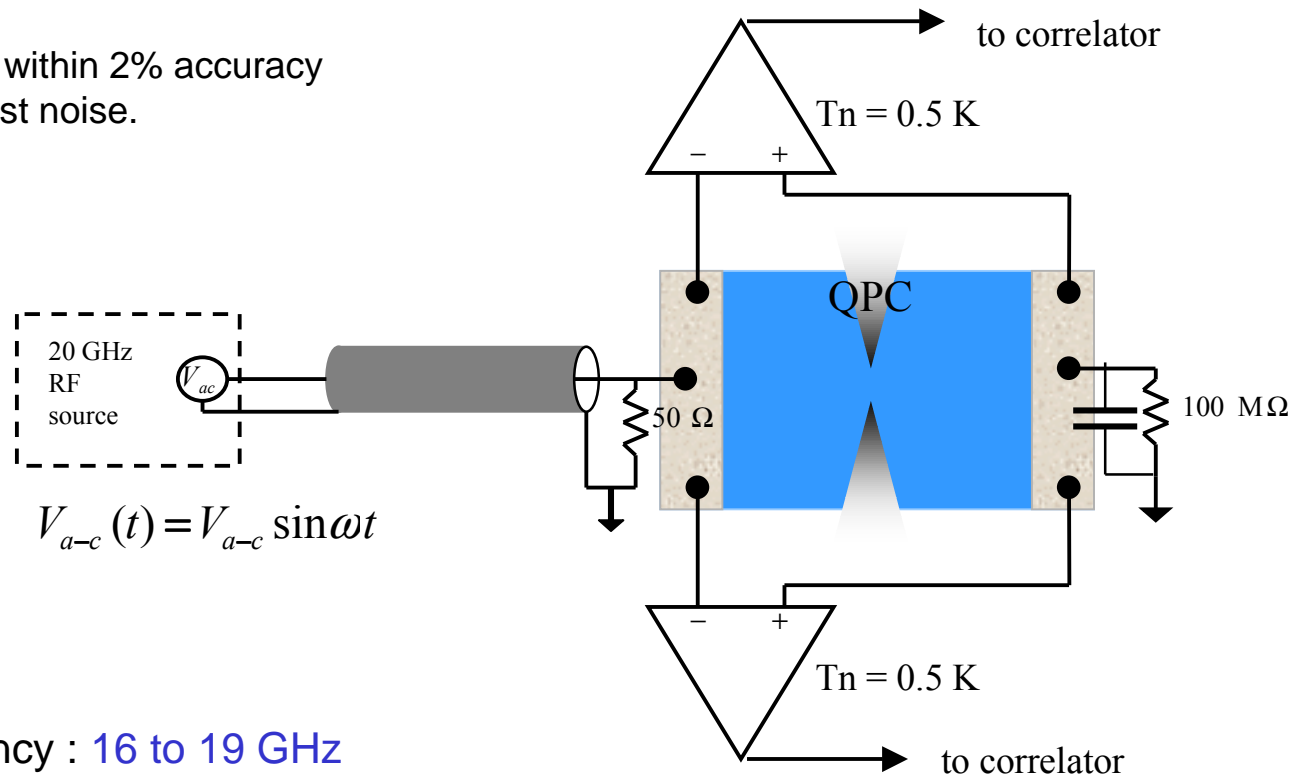

- excitation frequency : **16 to 19 GHz**

Non-transport shot noise measurement of the FANO factor of the electron-hole partitioning

(no dc V bias, no current !)

current noise power is expressed in units of the equivalent noise temperature :

$$T_{\text{Noise}} = \frac{S_I}{4G k_B}$$

$$\alpha = \frac{eV_{ac}}{h\nu} = 2.3$$

L-H. Reydellet, P. Roche and D.C. Glattli
Phys. Rev. Lett. **90**, 176803, (2003)

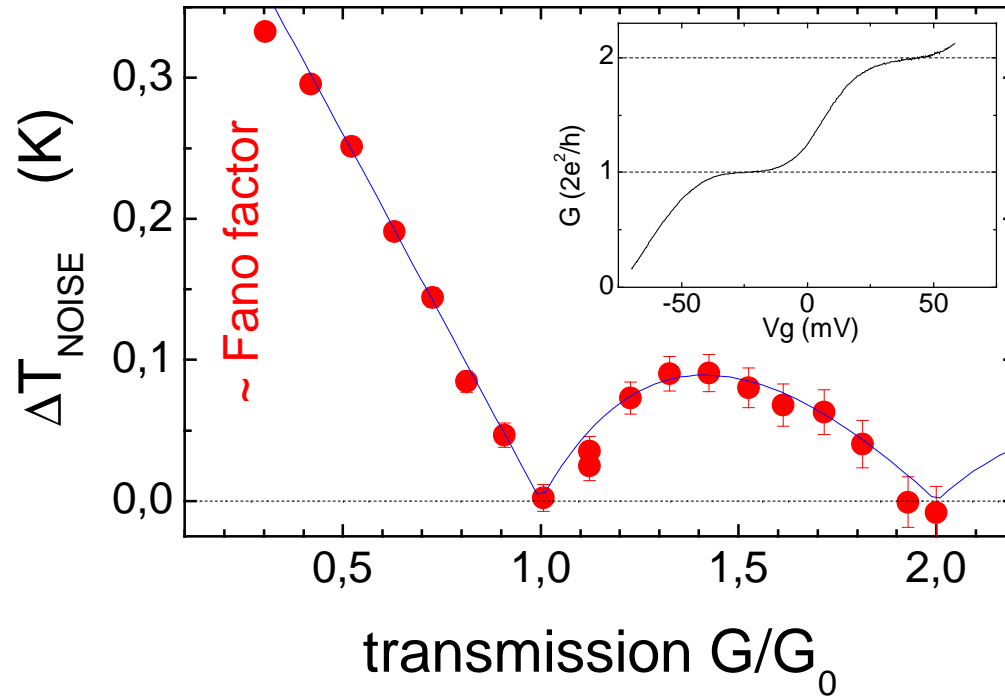

$$\frac{S_I}{4G k_B} = T \left(J_0^2(\alpha) + \frac{\sum D_n^2}{\sum D_n} (1 - J_0^2(\alpha)) \right) + \frac{h\nu}{k_B} \left(\sum_l l J_l^2(\alpha) \right) \frac{\sum_n D_n (1 - D_n)}{\sum_n D_n}$$

$$F = \frac{\sum_n D_n (1 - D_n)}{\sum_n D_n}$$

$\alpha = eV_{ac} / h\nu$, D_n , T are known : perfect agreement without adjustable parameter

Introduction

I. Electronic scattering (a brief introduction)

II. Quantum Shot noise

III Shot Noise and Interactions:

IV. Shot noise: *the* tool to detect entanglement

V. Shot noise and high frequencies

1. Photo-assisted Shot Noise
2. High frequency Shot Noise
3. Photon Noise emitted by a Conductor

V. 2. high frequency shot noise (detectable):

for simplicity : single mode conductor, two-terminal conductor and zero temperature :

$$S_1(\omega) = 2 \frac{e^2}{h} \left(\sum D_n (1 - D_n) \right) (eV - \hbar\omega) \quad \text{for } \hbar\omega < eV$$

$$= 0 \quad \text{for } \hbar\omega > eV$$

partition
noise

available
energy

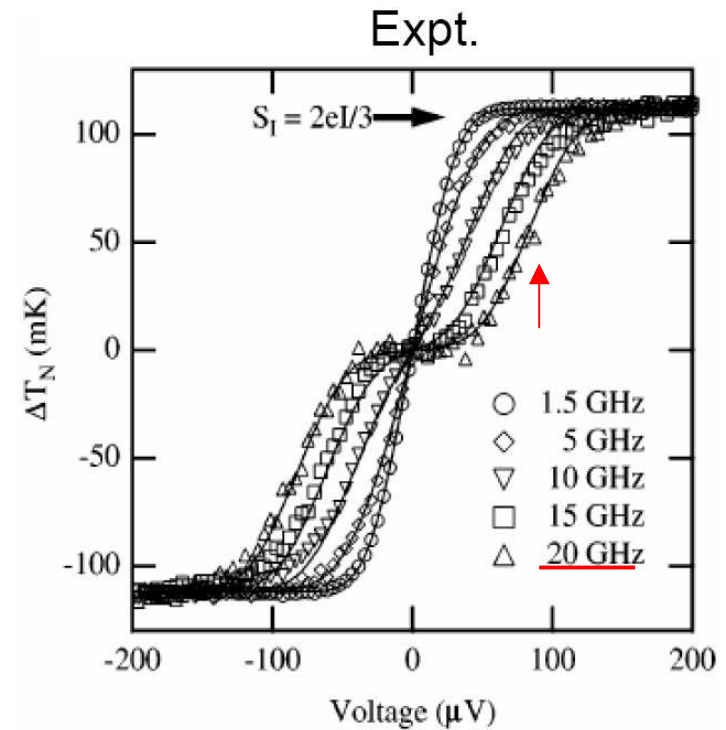
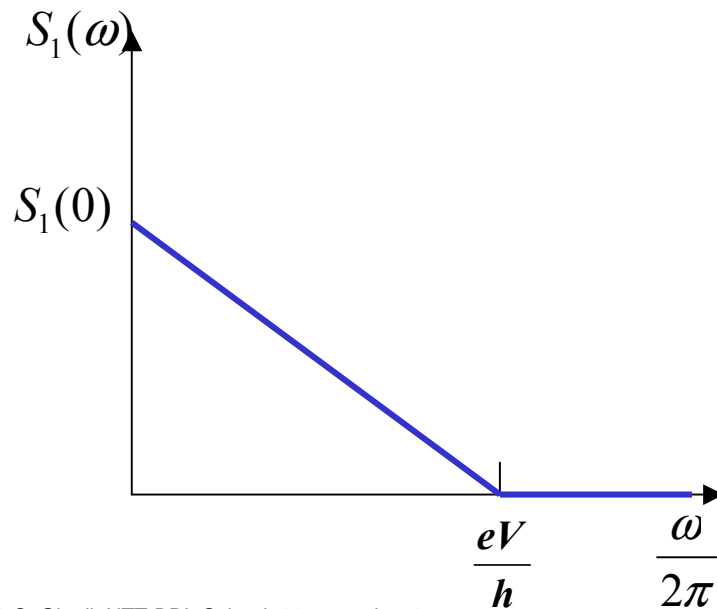

Schoelkopf et al., PRL **78**, 3370 (1998)

in general, for all coherent conductors one expects:

$$S_I(\nu) = S_I(0) (eV - h\nu) / eV$$
$$= 0 \quad \text{if} \quad eV < h\nu$$

Observed in a diffusive conductor (Schoelkopf et al., PRL **78**, 3370 (1998))

Not yet observed in other quantum conductor.

Recent interesting prediction: *C. Beenakker et al* Phys. Rev. Lett. **93**, 096801 (2004)

(also suggested in : *Gabelli et al*, Phys. Rev. Lett. **93**.056801 (2004))

sub-poissonian electron shot noise **statistics** can be transferred to the statistics of **photons** emitted by the conductor in the external circuit.

'low noise photons from low noise electrons'

V. 3. Photon Noise emitted by a Conductor

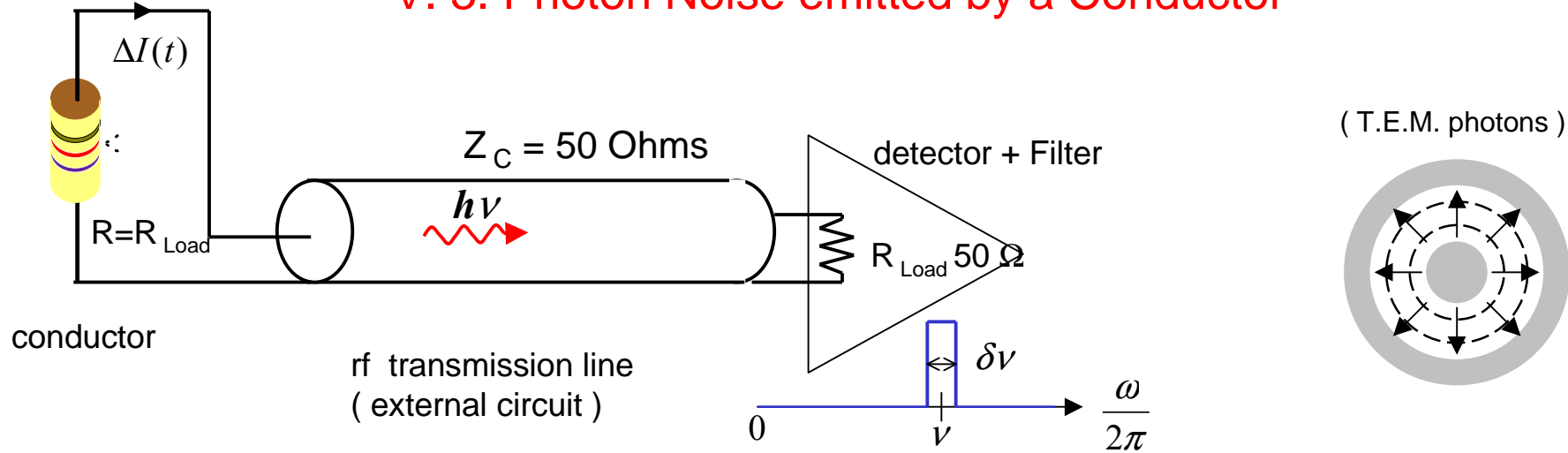

THERMAL AGITATION OF ELECTRIC CHARGE IN CONDUCTORS*

BY H. NYQUIST

In what precedes the equipartition law has been assumed, assigning a total energy per degree of freedom of kT . If the energy per degree of freedom be taken

$$h\nu / (e^{h\nu/kT} - 1) \tag{7}$$

where h is the Planck constant, the expression for the electromotive force in the interval $d\nu$ becomes

$$E_v^2 d\nu = 4R_v h d\nu / (e^{h\nu/kT} - 1) \tag{8}$$

Within the ranges of frequency and temperature where experimental information is available this expression is indistinguishable from that obtained from the equipartition law.

AMERICAN TELEPHONE AND TELEGRAPH COMPANY,
April, 1928.

power emitted in the transmission line:

$$P = \frac{R^2 Z_C}{(R + Z_C)^2} \Delta I^2 = \frac{R^2 Z_C}{(R + Z_C)^2} S_I(\nu) \delta\nu$$

current noise power at frequency ν

$$P = N(\nu) h \nu \delta\nu$$

TEM photon population at frequency ν

$$N(\nu) \Leftrightarrow S_I(\nu)$$

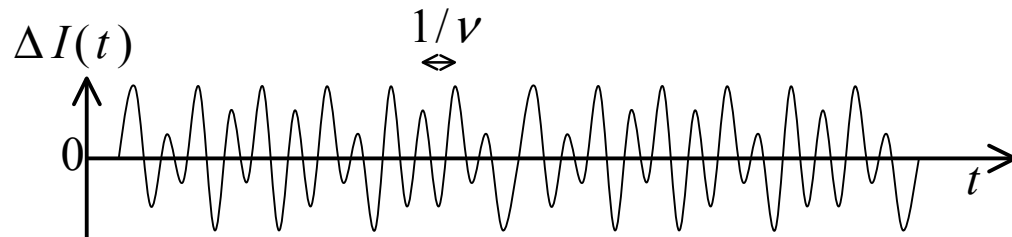
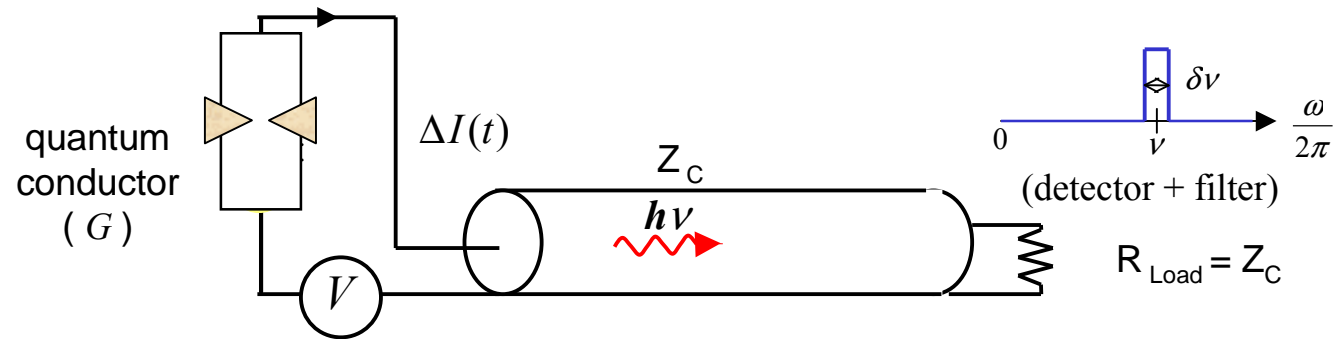

$$\overline{P(t)} = \overline{N} h\nu d\nu = \frac{Z}{(1 + GZ)^2} \overline{(\Delta I)^2}$$

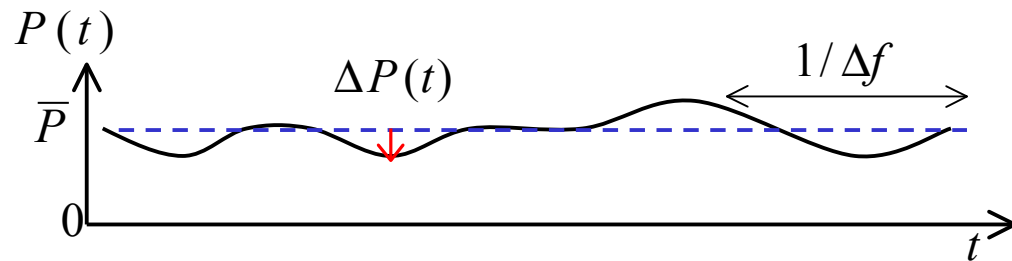

$$P(t) = \overline{P} + \Delta P(t) \rightarrow N = \overline{N} + \Delta N$$

$$\langle (\Delta P)^2 \rangle = \langle (\Delta N)^2 \rangle (h\nu)^2 \Delta\nu \Delta f$$

$$(\Delta N)^2 \Leftrightarrow (\Delta I)^4 - [(\overline{\Delta I})^2]^2$$

photon noise = noise of the current noise

photon **bunching** is expected at **low** frequency ν :

$$S_1(\omega) = 2e \frac{e}{h} D(1-D) \cdot (eV - h\nu) \quad \text{for } h\nu < eV$$

$$= 0 \quad \text{for } h\nu > eV$$

partition
noise

available
energy

For $h\nu \ll eV$, many electrons can emit similar photons which therefore bunch.

The photon population is

$$\propto \frac{eV - h\nu}{h\nu} \approx \frac{eV}{h\nu} \gg 1$$

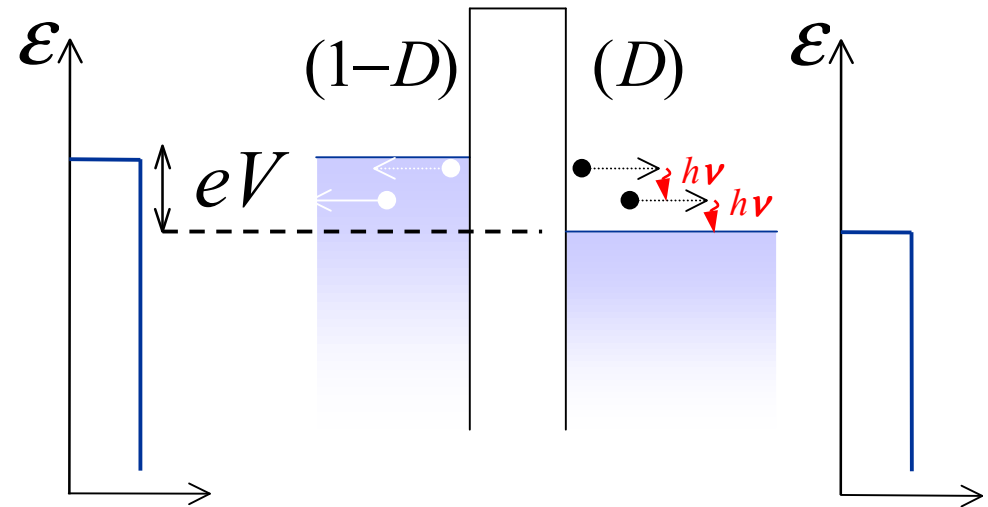
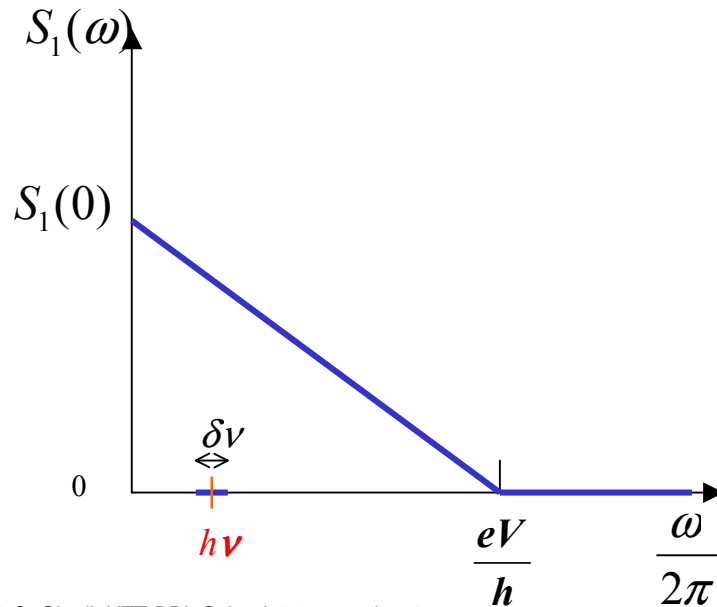

radiation is **super poissonian** (or 'classical')

sub-poissonian statistics is expected at high frequency !!:

$$S_1(\omega) = 2e \frac{e}{h} D(1-D) \cdot (eV - h\nu) \quad \text{for } h\nu < eV$$

$$= 0 \quad \text{for } h\nu > eV$$

partition noise

available energy

for $eV/2 < h\nu < eV$, an emitted photon correspond to a single electron

the photon population is

$$\approx \frac{eV - h\nu}{h\nu} \leq 1$$

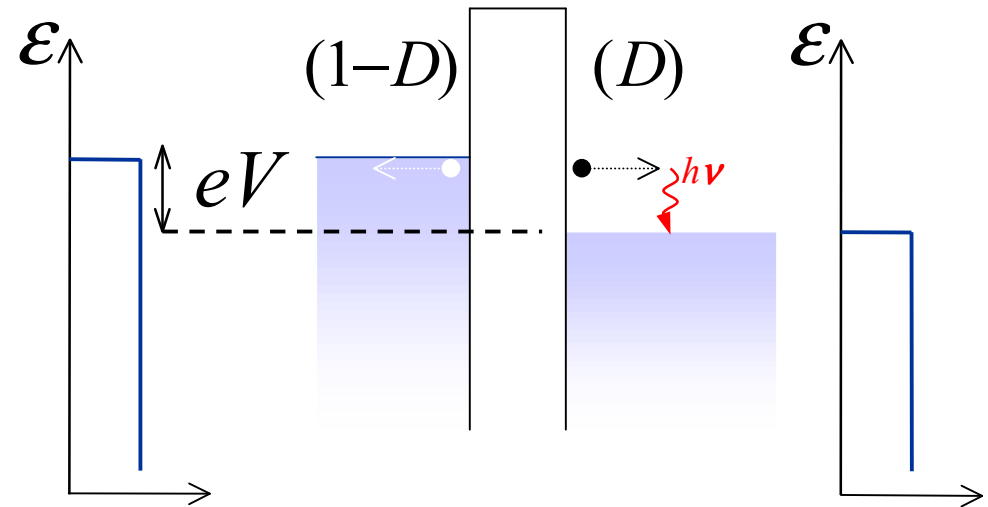
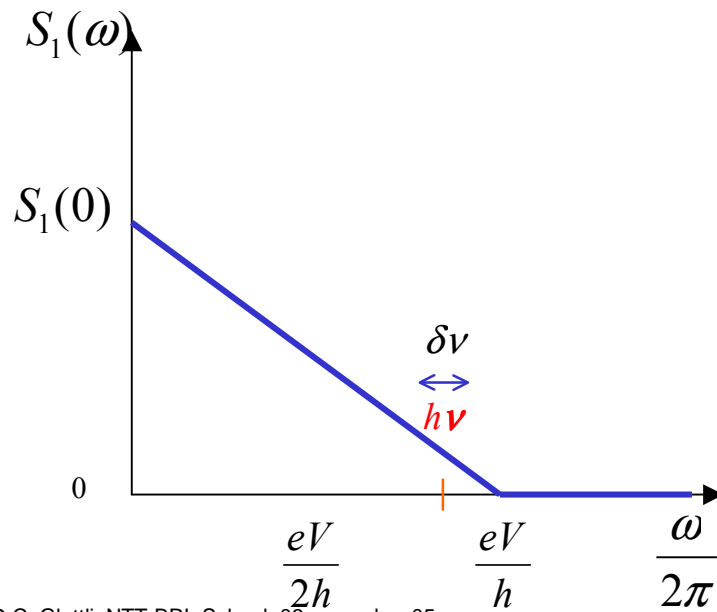

radiation is sub-poissonian (' non-classical ')

non-classical photon emission using shot noise in a Quantum Point Contact suggested in *Gabelli et al*, Phys. Rev. Lett. **93**,056801 (2004) and theoretically shown by *C. Beenakker et al* Phys. Rev. Lett. **93**, 096801 (2004)

photon mode population N :

$$\langle N \rangle = |S_{21}|^2 \frac{(1-D) eV - h\nu}{2 h\nu}$$

$$|S_{21}|^2 = \frac{4Z_C R}{(R + Z_C)^2}$$

impedance matching
'quantum efficiency'

$$\text{Var}(N) - \langle N \rangle = \langle N \rangle^2 \quad \text{if } eV \gg h\nu \quad (N \gg 1)$$

super-poissonian photon noise
(like black-body radiation)

$$\text{Var}(N) - \langle N \rangle = -\frac{2}{3} \langle N \rangle^2 \quad \text{if } eV/2 < h\nu \leq eV \quad (N \lesssim 1)$$

non-classical
photon noise !

numerical factor, depends on exact shape of filter (here uniform over $eV/2h$ bandwidth)

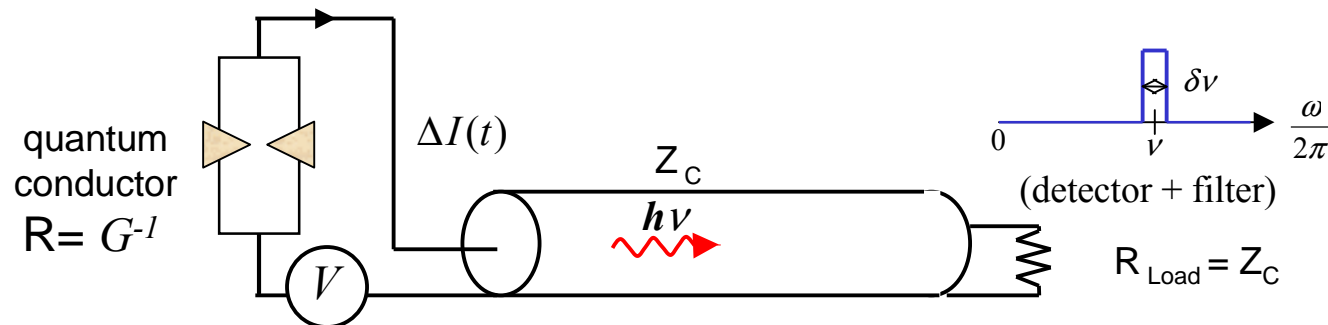

are anti-bunched photons observable?

- first step (**done**) (LPA ENS and SPEC Saclay):

reliable measure of the photon statistics of coaxial TEM modes
(GHz Hanbury-Brown Twiss experiment)

Gabelli et al, Phys. Rev. Lett. **93**.056801 (2004)

- next step (**to be done**) (SPEC Saclay)

impedance matching and detection

Quantum Optics at cell-phone frequencies

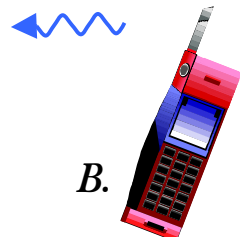

DO CO MO Physics

J. Gabelli et al., PRL. 93, 056801 (2004)

Hanbury-Brown Twiss GHz Photon experiment

1) thermal source (black body)

$$\bar{N}_A = f_{BE} \left(\frac{h\nu}{kT_A} \right) = \frac{1}{e^{h\nu/kT_A} - 1}$$

$$\overline{\Delta N_1^2} = \bar{N}_1 (1 + \bar{N}_1)$$

$$\overline{\Delta N_2^2} = \bar{N}_2 (1 + \bar{N}_2)$$

$$\overline{\Delta N_1 \Delta N_2} = +\frac{1}{4} (\bar{N}_A - \bar{N}_B)^2$$

super-poissonian noise, positive correlations

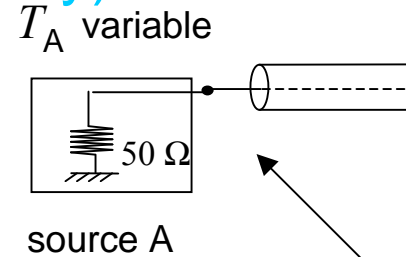

source A

source A

source B
(vacuum)

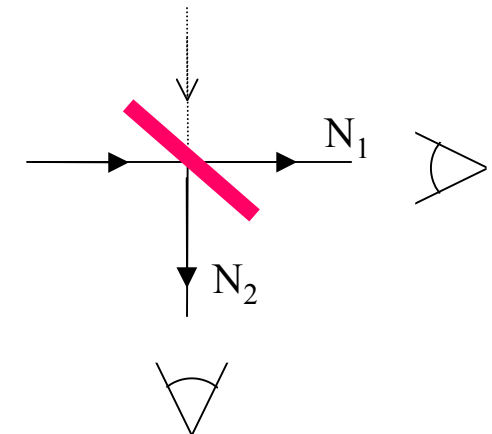

2) coherent source (like LASER)

$$\overline{\Delta N_1^2} = \bar{N}_1$$

$$\overline{\Delta N_2^2} = \bar{N}_2$$

$$\overline{\Delta N_1 \Delta N_2} = 0$$

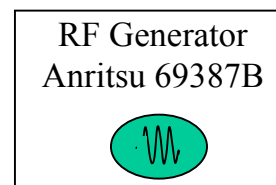

Source B

$$\bar{N}_1 = D \bar{N}_A + (1 - D) \bar{N}_B$$

$$\bar{N}_2 = (1 - D) \bar{N}_A + D \bar{N}_B$$

$$D = 1/2$$

Poissonian noise, no correlations

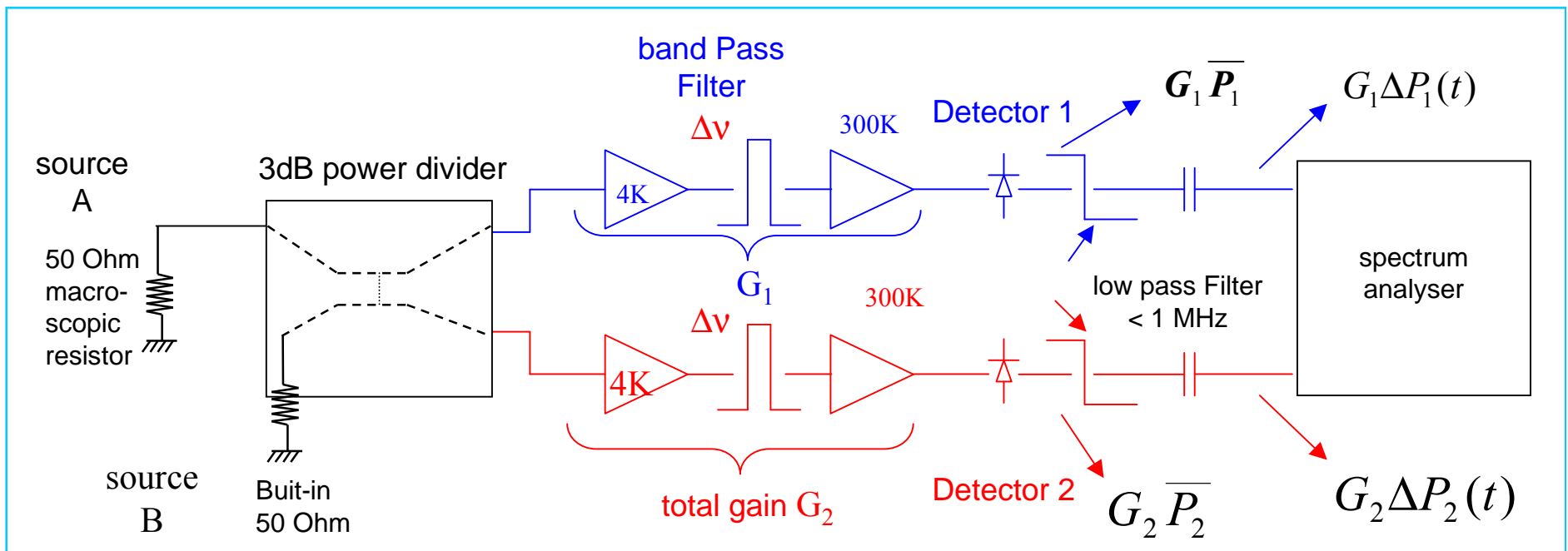
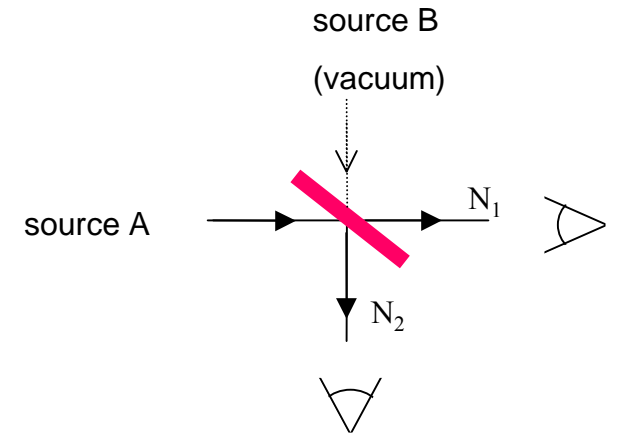
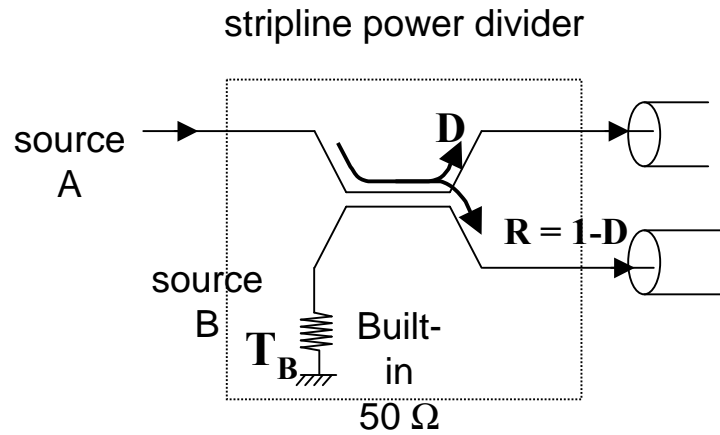

frequency range 1 to 2 GHz

temperature range 10 mK to 10K

ultra-low noise cryogenic amplifiers

$$h\nu = k_B T \rightarrow 1.5 \text{ GHz} = 75 \text{ mK}$$

photon statistics at cell phone frequencies

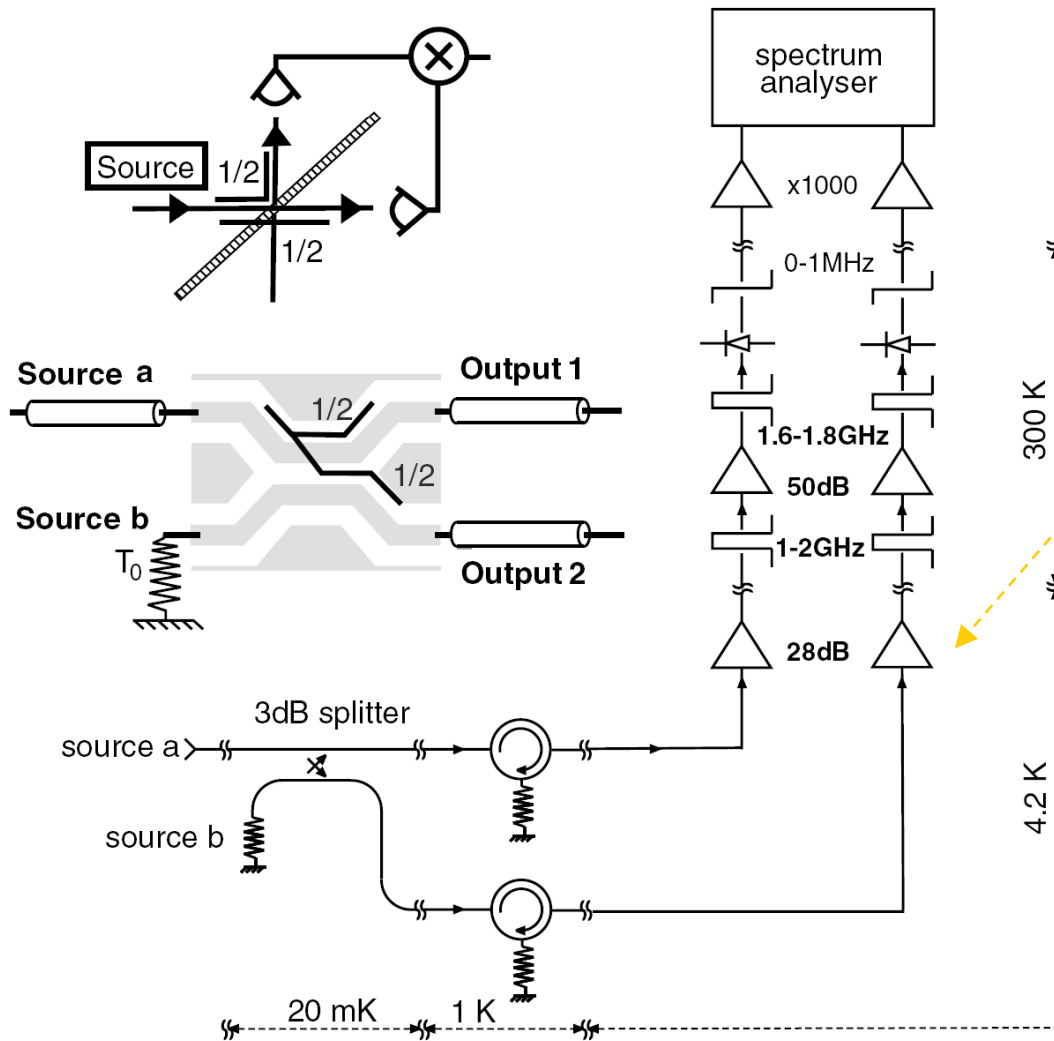

1 - 2 GHz cryogenic
radiofrequency amplifier
 $T_N \sim 4$ and 6 Kelvin

$h\nu = 50 - 100$ mK

' GHz photon
beam splitter '

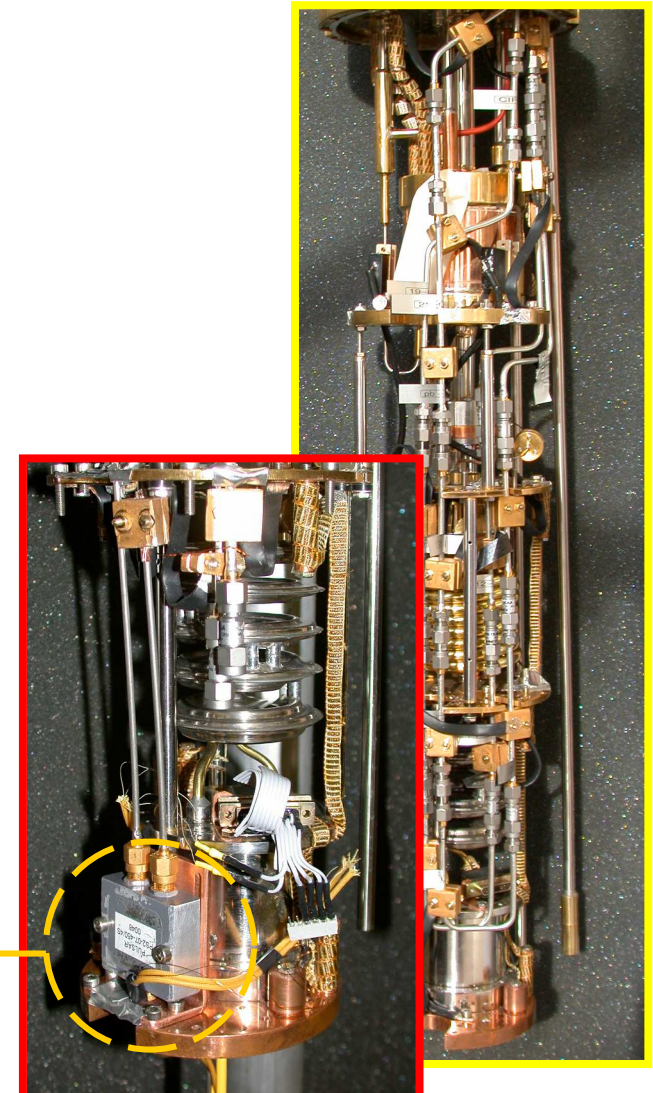

1) thermal source

$$\bar{N}_A = f_{BE} \left(\frac{h\nu}{kT_A} \right) = \frac{1}{e^{h\nu/kT_A} - 1}$$

$$\overline{\Delta N_1^2} = \bar{N}_1 (1 + \bar{N}_1)$$

$$\overline{\Delta N_2^2} = \bar{N}_2 (1 + \bar{N}_2)$$

$$\overline{\Delta N_1 \Delta N_2} = + \frac{1}{4} (\bar{N}_A - \bar{N}_B)^2$$

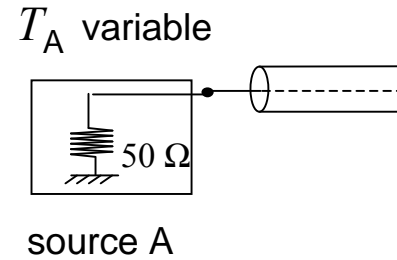

super-poissonian noise, positive correlations

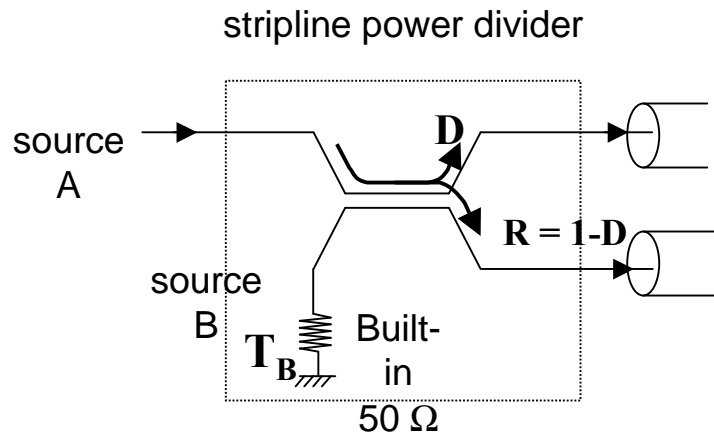

$$T_B \ll h\nu$$

$$N_B = 0$$

Thermal photons : quantum regime $N \sim 1$

J. Gabelli et al., PRL. 93, 056801 (2004)

$$N_{(a)} = \frac{1}{\exp\left(\frac{h\nu}{k_B T_A}\right) - 1}$$

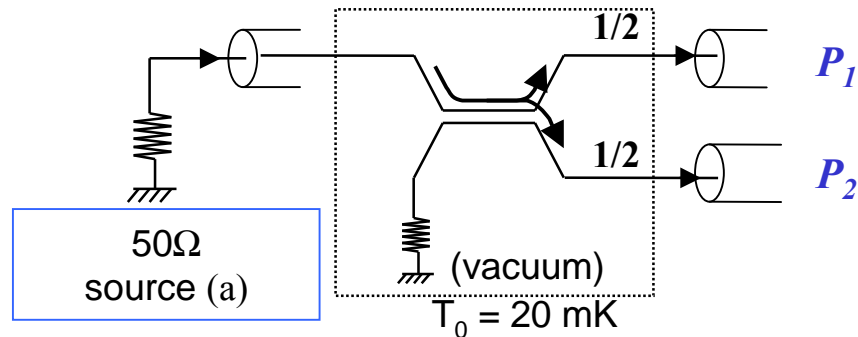

quantum cross-over @ $T_Q = h\nu/2$

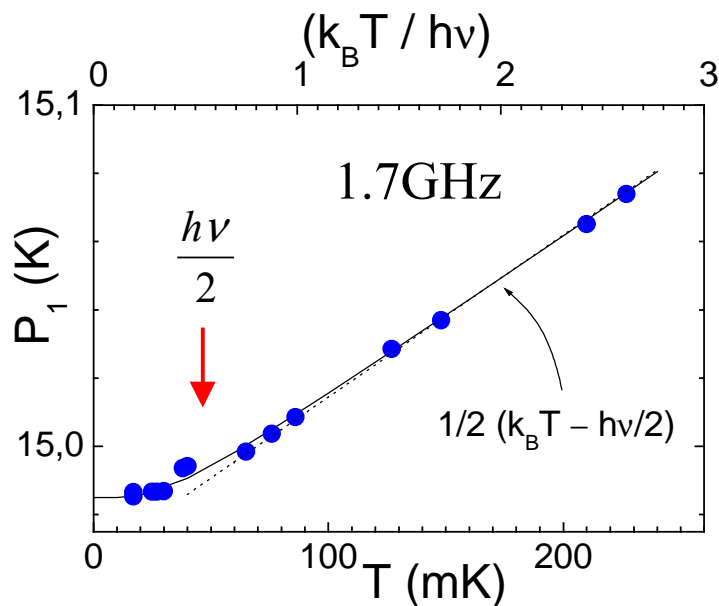

Bose-Einstein distribution

$$P_1 = P_{N_1} + \frac{1}{2} h\nu \frac{1}{\exp\left(\frac{h\nu}{k_B T}\right) - 1}$$

$$\nu = 1.7 \text{ GHz}$$

$$\frac{h\nu}{2} = 38 \text{ mK}$$

$$\delta\nu = 0.1 \text{ GHz}$$

sensitivity :

$$\delta T \approx \frac{T_N}{\sqrt{\delta\nu \tau}} < \text{ mK for } \tau = 1 \text{ s}$$

Thermal photons : quantum regime $N \sim 1$

J. Gabelli et al., PRL. 93, 056801 (2004)

$$N_{(a)} = \frac{1}{\exp\left(\frac{h\nu}{k_B T_A}\right) - 1}$$

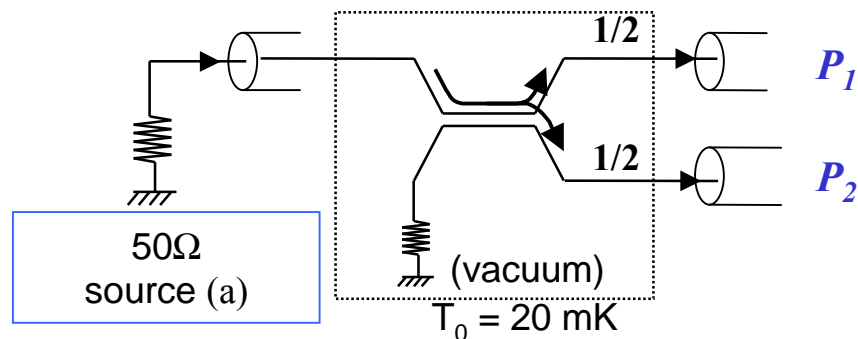

quantum cross-over @ $T_Q = h\nu/2$

positive cross-correlations

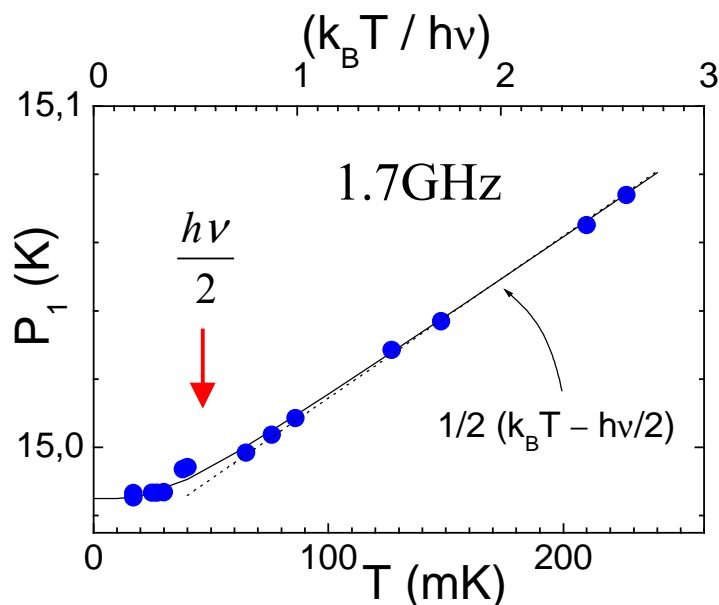

Bose-Einstein distribution

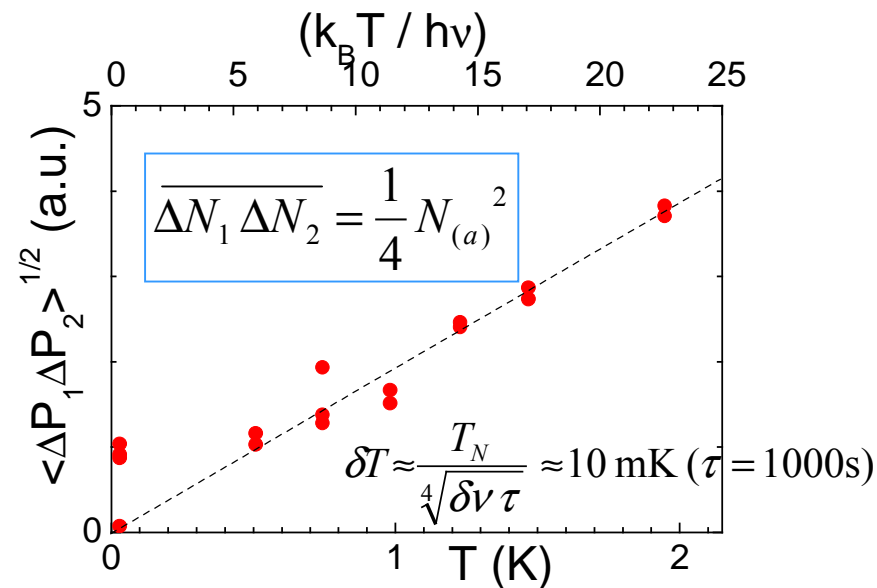

Superpoissonian correlations

sensitivity to different photon statistics?

2) coherent source

Source A: low phase noise RF generator - similar to optical LASER

$$\overline{\Delta N_1^2} = \bar{N}_1$$
$$\overline{\Delta N_2^2} = \bar{N}_2$$
$$\overline{\Delta N_1 \Delta N_2} = 0$$

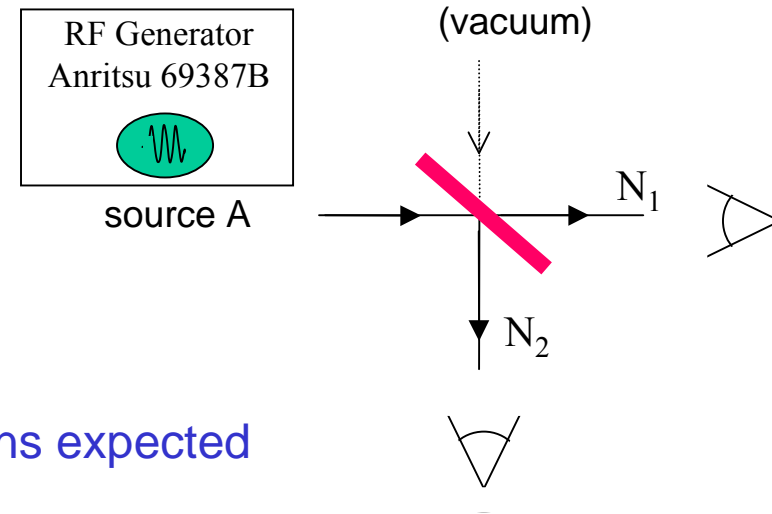

Poissonian noise, no cross-correlations expected

1.5GHz coherent source : poissonian noise

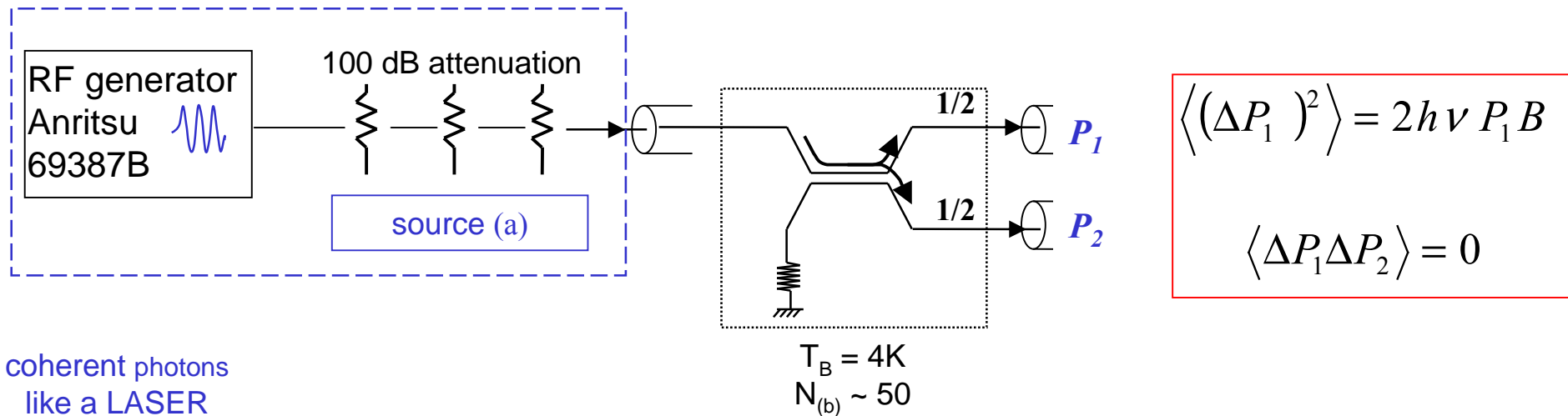

coherent photons
like a LASER

quantum description of the amplifiers

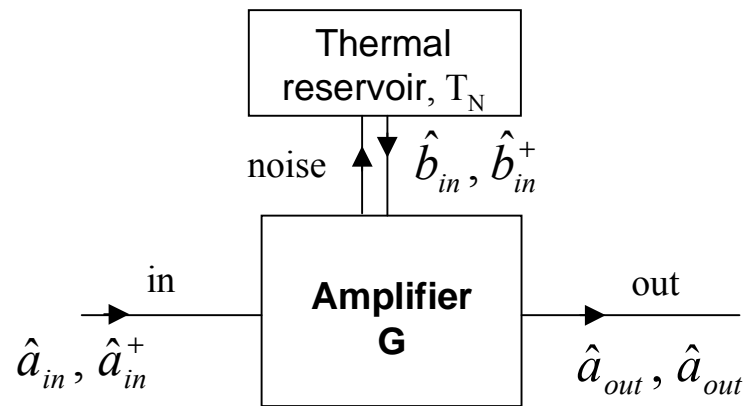

Photon creation
and annihilation
operators

$$\hat{a}_{out} = \sqrt{G} \hat{a}_{in} + \sqrt{G-1} \hat{b}_{in}^+$$

$$|\alpha\rangle = e^{-|\alpha|^2/2} \sum_{n=0}^{\infty} \frac{\alpha^n}{\sqrt{n!}} |n\rangle$$

$$F = 1 + \frac{k_B T_N}{h\nu}$$

$$\langle (\Delta P_1)^2 \rangle = 2 F h \nu P_1 B$$

$$\langle \Delta P_1 \Delta P_2 \rangle = 0$$

1.5GHz coherent source : poissonian noise

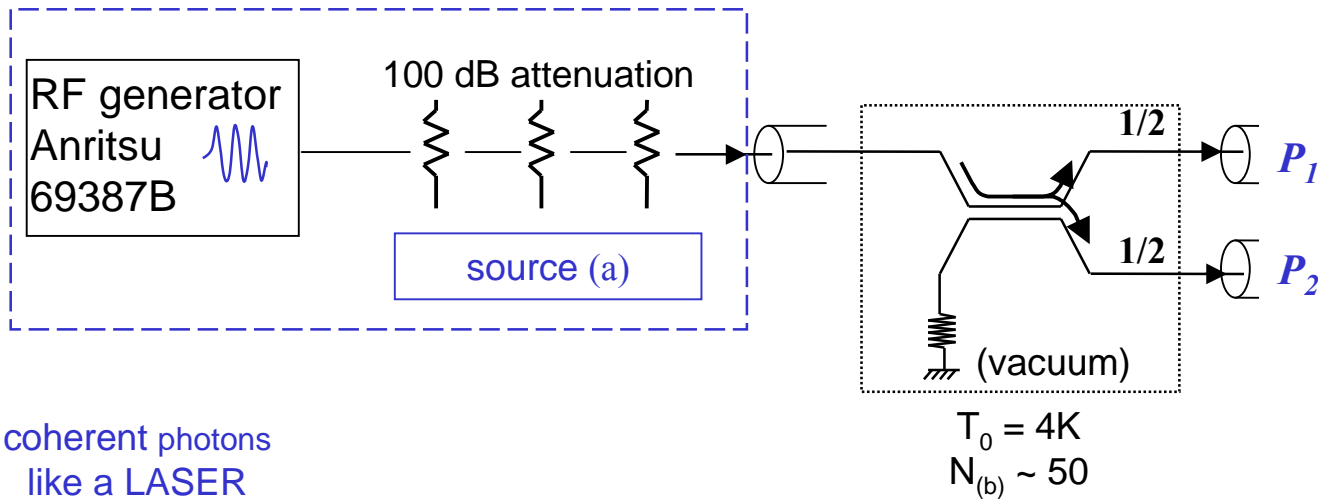

$$\langle (\Delta P_1)^2 \rangle = 2h\nu P_1 B$$

$$\langle \Delta P_1 \Delta P_2 \rangle = 0$$

coherent photons
like a LASER

after amplification : Poissonian noise, no correlations

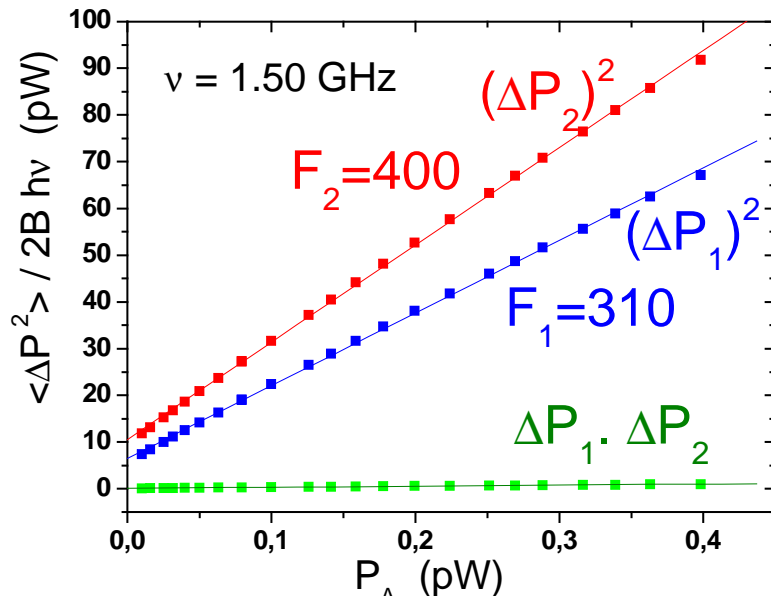

D.C. Glattli, NTT-BRL School, 03 november 05

$$\langle P_1 \rangle = \left(\frac{P_A}{2} + k_B (T_0 + T_N) \Delta\nu \right)$$

$$\langle \Delta P_1 \Delta P_2 \rangle = 0$$

$$\langle (\Delta P_1)^2 \rangle = 2h\nu F \frac{P_{(a)}}{2} B + 2k_B^2 (T_0 + T_N)^2 B \Delta\nu$$

$$\text{Giant Fano factor} : F = 1 + 2k_B \frac{T_0 + T_N}{h\nu} \approx 300$$

J. Gabelli et al., PRL. 93, 056801 (2004)

Quantum Optics at cell-phone frequencies

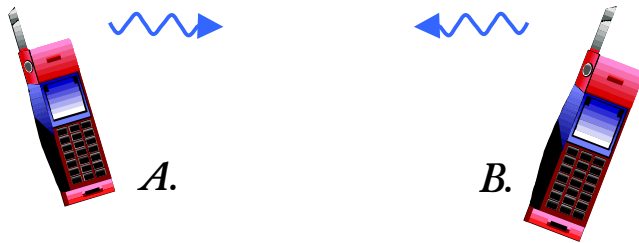

DO CO MO Physics

J. Gabelli et al., PRL. 93, 056801 (2004)

statistics of photons emitted by quantum conductor : new quantum noise problem

Fermi statistics **regulates emission of photons** having frequency close to eV/h

no experimental observation yet

including interactions is not solved

designed of a GHz photon Hanbury-Brown Twiss experiment

tested on **thermal** photon noise emitted by resistor at equilibrium
and on **coherent** microwave source

can be used to investigate non-classical statistics of **microwave photons**

conclusion

shot noise probes **two-electron** physics

shot noise exemplifies beautiful aspects of the **Fermi statistics**

- (conductance quantization)
- noiseless electrons
- entanglement for free
- noiseless photons

shot noise allows to accurately investigate the effect of interactions:

- charge carriers (fractional : FQHE or doubled : S-N)
- correlated systems

not covered in this talk :

- full counting statistics
- photo-assisted shot noise correlations
- mesoscopic detectors of shot noise
- detector shot noise and decoherence of two-level systems.
- ... (probably endless)